

60c ■ JULY 1972

Radio-Electronics®

FOR MEN WITH IDEAS IN ELECTRONICS

For better stereo-use
TEST TAPES AND RECORDS

Build with op-amps
ACCURATE MULTIMETER

Modern radio techniques
SSB MADE EASY

Careers in electronics
TECHNICIAN IN THE FIELD

SUPERCLOCK—NEW DIGITAL TIMEKEEPER

586164 000 71TEEL96 JUL73 0 A
07 4
THE ELECTRONIC HOSP
7 1-2 W CHURCH ST
FAIRPORT NY 14450

**VTR's—
Yesterday—
Today—
Tomorrow**



GERNSBACK
PUBLICATION

We compared our new deluxe preamp to a 10¢ piece of wire.

First we ran a signal through a 10¢ length of shielded cable. What came out the other end was, of course, audibly identical to what went in. Then we ran the same signal through our new TA-2000F preamplifier, and ran an A-B comparison between its output and the wire's. Both were audibly identical. As we'd expected.

This is not to say that sufficiently precise instruments could not detect inaudible differences between our preamp's signal transmission and a wire's. Whereas a straight wire has no distortion whatsoever, we must admit to having some—three hundredths of one per cent harmonic, and five hundredths of one per cent intermodulation, maximum, at rated output. And whereas a wire theoretically does generate some noise, its signal-to-noise ratio is still somewhat better than the 73dB obtained through the TA-2000F's phono inputs, or even the 90dB obtained through our Aux, Tape and Tuner inputs.

But, as you'd expect, the big difference in price between our deluxe preamp and two feet of cable, buys a great deal more than just a pure, clean signal. As our preamp's 58 levers, switches, meters, knobs and jacks would indicate.

NEARLY 2,000 RESPONSE SETTINGS

Six of those controls are devoted to precise adjustment of frequency response. The calibrated, 2dB-per-step, bass and treble controls have switches that adjust their turnover frequencies, so you can choose how deeply the tone controls will affect—or not affect the midrange. Still another switch cuts the tone controls out of the circuit altogether. And a single knob controls the sharply-cutting, 12dB-per-octave, 50Hz and 9kHz filters. Together, these six controls give you a choice of 1,935 *precisely repeatable* response settings including flat (10Hz-100kHz, +0, -2dB) response.

The facilities for tape recording are exceptional and unique; you can record on two tape decks at once, monitoring either (or your program source) at the flick of a switch. You can dub from one machine directly to the other, without external patching or connections. For straight microphone recordings, there's a mic input position on the function

selector knob; for voice-over-music, there's a separate mic level control that diminishes all other input signals as it increases the microphone level.

And, of course, the two, front-panel VU meters, are as useful for testing as they are for monitoring record levels.

TOTAL INPUT AND OUTPUT FLEXIBILITY

The TA-2000F can feed two stereo amplifiers (and an additional monophonic or center-channel amp) at one time, at either a 1 volt or 300mV level. The second amplifier output could also be used for still another tape recorder, should you wish to use the ultra-versatile tone controls and filters in recording. The front-panel output jack feeds both high- and low-impedance headphones, or can be used as a tape output, by suitable adjustment of its independent level control; the same knob also controls the center-channel output.

Five of the 8 rear-panel stereo inputs have rear-panel level adjustments. A sixth—the Phono 1 input—has a switch that selects three separate input impedances at the normal 1.2mV sensitivity setting, and two more impedances at the 0.06mV setting that lets you use even the lowest-output cartridges.

96 TRANSISTORS VERSUS A SINGLE WIRE

But all these features merely make our TA-2000F more versatile than any wire. They don't explain how we can come so close to the wire's pure, unadulterated performance. That explanation will rest with our circuit designers, and with the 96 *high voltage*, and Field Effect transistors they used.

THE TA-3200F: AN AMPLIFIER TO TRULY COMPLEMENT OUR PREAMP
A preamplifier like the TA-2000F deserves, of course, its complement in a

power amplifier. Not too surprisingly, we make one: the Sony TA-3200F. Its fully direct-coupled circuitry produces 200 watts continuous (RMS) at 8 ohms, with power bandwidth from 5 to 35,000Hz. IHF Dynamic Power is rated at 320 watts into 8 ohms (and fully 500 watts into a 4 ohm load). Its distortion, at a listening level of one half watt, matches the preamplifier's at 0.03%; at full rated output, it is still a mere 0.1%. And the signal-to-noise ratio is 110dB.

Our amplifier's facilities nearly match our preamp's. The 3200F has controls you've rarely, if ever, seen on power amps before: switch-selected stereo input pairs; a speaker selector switch; a power limiter (which holds output down to 25 or 50 watts, should you so desire), and a rear-panel switch that lets you limit bass response below 30Hz., instead of letting it extend to 10Hz.

For further information, see your Sony dealer, or write us. Or wire. Sony Corporation of America, 47-47 Van Dam Street, Long Island City, N.Y. 11101.



SONY®

Circle 1 on reader service card

Sams guides you through the highways and byways of electronics

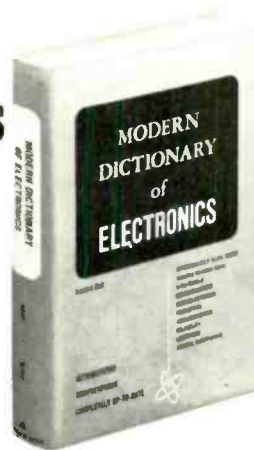

MODERN DICTIONARY OF ELECTRONICS 4th Edition

by Rudolf F. Graf

Completely updated definitions of approximately 18,500 terms used in the fields of communications, microelectronics, fiber-optics, semiconductors, reliability, computers, and medical electronics. Over 2000 terms have been added, and hundreds of definitions have been updated. An invaluable reference.

SAVE! SPECIAL PREPUBLICATION PRICE!

No. 20852

Only \$11.95 if ordered before Aug. 1, 1972. After Aug. 1, 1972, regular price will be \$12.95.

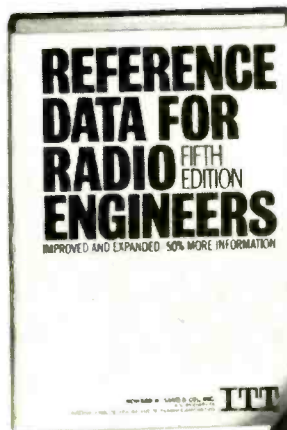

REFERENCE DATA FOR RADIO ENGINEERS FIFTH EDITION

IMPROVED AND EXPANDED 50% MORE INFORMATION

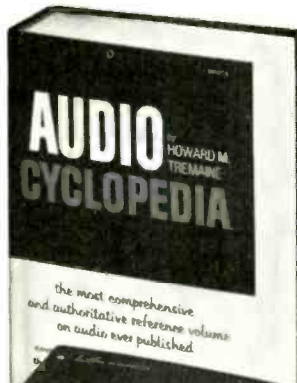

AUDIO CYCLOPEDIA 2nd Edition

the most comprehensive and authoritative reference volume on audio ever published

REFERENCE DATA FOR RADIO ENGINEERS 5th Edition

Covers transistors, electro-acoustics, microminiature electronics, space communication, navigation aids, quantum electronics, reliability and life testing. Completely revised by over 100 experts. 50% more data than previous edition. Over 400,000 copies in use. 1696 pgs., 1350 illustrations.

No. 20678 \$20.00

AUDIO CYCLOPEDIA 2nd Edition

by Dr. Howard M. Tremaine

The most comprehensive and authoritative reference text on audio ever published. 1758 pages, over 3500 topics, and 1800 illustrations devoted to the fields of acoustics, recording and reproduction. Completely updated.

No. 20675 \$29.95

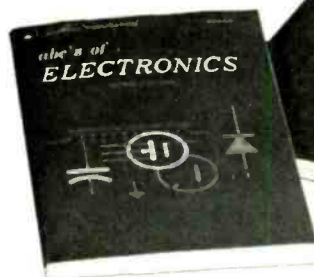

ABC'S OF ELECTRONICS 2nd Edition

by Earl J. Waters

Clearly explains the principles of electricity; functions of atoms and electrons; magnetic forces and their relationship to electronics; basic components and their applications; fundamental electronic circuits and how they work. Latest information on solid state devices.

No. 20865 \$3.95

TRANSISTOR TV TRAINING COURSE 2nd Edition

by Robert G. Middleton

This training course in solid-state tv circuitry is a valuable guide for both the technical student and the experienced tv technician. It includes such late developments as integrated circuits, dual-gate MOSFETS and SCR sweep circuits, and the most recent innovations in solid state color tv circuitry.

No. 20882 \$4.50

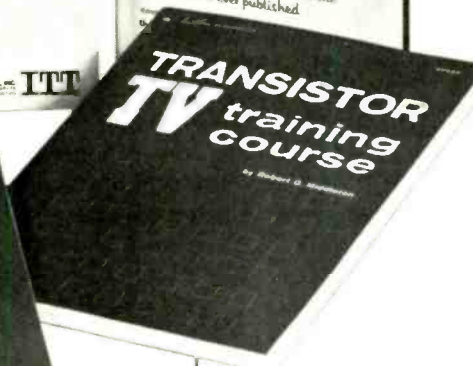

STUDY GUIDE FOR CET EXAMINATIONS

by J. A. Wilson, CET and Dick Glass, CET

A programmed text giving full coverage of typical questions encountered in the CET examination, together with the answers. For background information, the chapters are keyed to the two Sams television courses described at the right.

No. 20834 \$5.95

COLOR TV TRAINING MANUAL 3rd Edition

by the Howard W. Sams Editorial Staff

A step-by-step education in the intricacies of color-tv. Its explanation of the basic principles of each circuit leads to a clear understanding of the overall function of the set. A widely used text for schools and self study, it embraces modern developments in color-tv circuitry.

No. 20736 \$6.95

PHOTOFACT® TELEVISION COURSE 3rd Edition

by the Howard W. Sams Editorial Staff

This basic and comprehensive explanation of black-and-white television has helped thousands become proficient in television theory and servicing. Includes timely information on transistor circuits.

No. 20595 \$4.95

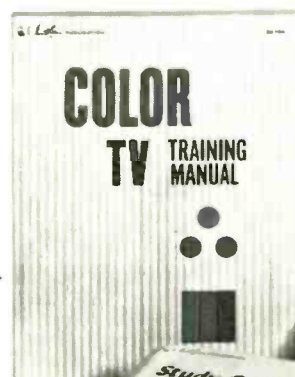

RE 072



Order from your Electronics Parts Distributor, or mail to Howard W. Sams & Co., Inc., 4300 West 62nd St., Indianapolis, Ind. 46268.

Send books checked below. \$_____ enclosed. Please include sales tax where applicable. Canadian prices slightly higher.

_____ Send FREE 1972 Sams Book Catalog.

Name _____

Address _____

City _____ State _____ Zip _____

20852 20678 20675 20865 20882 20834 20736 20595



HOWARD W. SAMS & CO., INC.
4300 W. 62nd Street
Indianapolis, Ind. 46268

Circle 2 on reader service card

There's
an **Amperex**
replacement tube
for any socket in any set
you're likely to service...

TV, HiFi, FM or AM,
House Radio, Car Radio,
P.A. System or Tape Recorder.
Imported or Domestic!

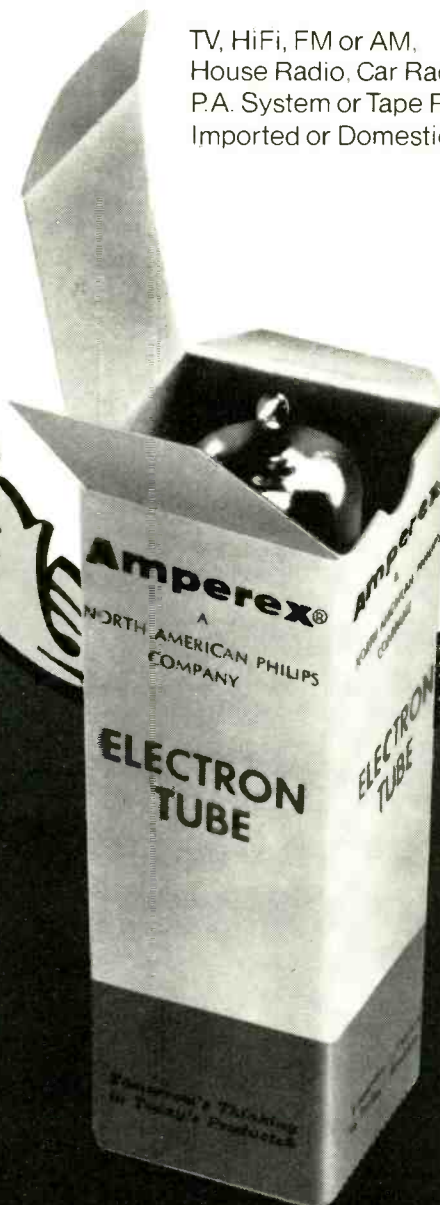

AMPEREX SUPPORTS THE INDEPENDENT SERVICE DEALER

Amperex[®]

TOMORROW'S THINKING IN TODAY'S PRODUCTS

A NORTH AMERICAN PHILIPS COMPANY

Radio-Electronics

FOR MEN WITH IDEAS IN ELECTRONICS

July 1972

SPECIAL FEATURES

- 33 **Video Tape Recorders—ready for your home?**
Yesterday—Today—Tomorrow. *by Fred Petras*
- 36 **Video Tape Recorders Roundup**
Details of units you can buy today. *by Fred Petras*

GENERAL ELECTRONICS

- 4 **Looking Ahead**
Current happenings. *by David Lachenbruch*
- 22 **Appliance Clinic**
The ground-fault interrupter. *by Jack Darr*
- 45 **Electronic Technician In the Field**
A profile of the technicians place in electronics. *by L. L. Farkas*
- 52 **Op-Amp VOM**
Circuit details of a vom built with operational amplifiers. *by B. R. Rogen*
- 59 **Breadboarding Digital Circuits**
Use R-E's IC tester to do it fast. *by Jack Cazes*
- 76 **Low-Ohms Story**
How the new low-ohms circuits operate. *by Walter Cerveny*

BUILD THIS ONE

- 54 **Superclock—Unique Digital Timekeeper**
6-digit readout and time-zone switching are two of the important features. *by Don Lancaster*

TELEVISION

- 27 **Equipment Report**
RCA Quicktracer transistor checker.
- 41 **Kwik-Fix Troubleshooting Charts**
Second video amplifier in transistor color sets. *by Forest H. Belt*
- 62 **Service Clinic**
Solid-state replacements for rectifier tubes. *by Jack Darr*
- 63 **Readers Questions**
R-E's Service Editor solves reader service problems

STEREO HI-FI AUDIO

- 24 **For Better Stereo Use Test Tapes and Records**
What they do and how to use them effectively. *by Peter E. Suthem*

RADIO

- 32 **Equipment Report**
International Crystal 6024 frequency meter.
- 38 **Single-Sideband Made Easy**
How this modern radio technique works. *by Fred Shunaman*

DEPARTMENTS

- | | |
|-----------------------------|--------------------------------|
| 101 Books | 75 New Literature |
| 93 Coming Next Month | 72 New Products |
| 16 Letters | 103 Reader Service Card |
| 6 New & Timely | 85 Technotes |



LOW-COST VTR's are coming, but how long before they reach your home? Two VTR stories start on.....page 33

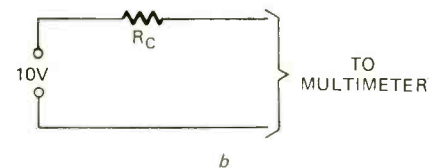
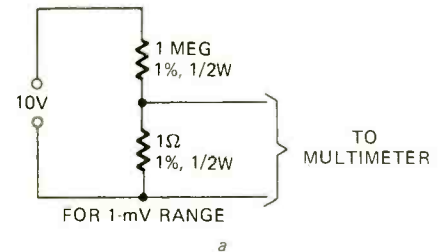

A volt-ohm meter can be easily built using an op-amp and some range dividers like the one shown here.see page 52

Hugo Gernsback (1884-1967)
founder

M. Harvey Gernsback, editor-in-chief
and publisher

Larry Steckler, editor

Robert F. Scott, W2PWG technical editor. CET

Jack Darr, service editor

Louis E. Garner, Jr., semiconductor editor

I. Queen, editorial associate

Matthew Mandl, contributing editor

David Lachenbruch, contributing editor

James A. Gupton, Jr., photographic electronics

Vincent P. Cicenia, production manager

Nancy Gipson, production assistant

H. Matysko, circulation

Cover photograph by Walter Herstatt

Cover design by Marius Trinqu

Radio-Electronics is indexed in *Applied Science & Technology Index and Readers Guide to Periodical Literature.*



Radio-Electronics, July 1972, Vol. 43, No. 7. Published monthly by Gernsback Publications, Inc., 200 Park Avenue South, New York City 10003. Second-class postage paid at New York, N. Y. and additional mailing office. One-year subscription rate: U.S.A., U.S. possessions and Canada, \$7. Pan-American countries, \$8. Other countries, \$8.50. Single copies, 60¢. ©1972 by Gernsback Publications, Inc. All rights reserved. Printed in U.S.A.

Subscription Service: Mail all subscription orders, changes, correspondence and Postmaster Notices of undelivered copies (Form 3579) to Radio-Electronics Subscription Service, Boulder, Colo. 80302.

looking ahead

Telegames

The first home product designed to convert the family television set from a passive to an active entertainment and education device will be placed on the market this fall by Magnavox. It's an ingenious gadget called "Odyssey" which transforms the television set to a game board for adults or children and an instructional display for pre-schoolers and early elementary students. In brief, Odyssey is a computerized device that attaches to the home television set and has two stations which permit participants to control the location of dots of light which appear on the screen. These dots interact with each other or with a third dot to produce a wide variety of entertainments.

Each Odyssey is equipped with 12 printed-circuit cards that are inserted in a slot of the control box—each one for a different game or activity. Colorful plastic overlays, which adhere to the faceplate by static electricity, are provided for each game. Each activity is designed for two participants, one at each control station. Each station, connected to the main control box by a flexible cable, is equipped with four controls—horizontal, vertical, "English" and reset. As an example of how Odyssey works, take the ping-pong game: The "ping-pong" card is inserted into the slot. Two small squares appear on the screen, one representing each player, separated by a vertical line—the net. The overlay, a bird's-eye-view of a ping-pong table, is attached to the screen. One player pushes his "reset" button to serve the ball—another square of light—which shoots over the net. The second player manipulates his controls so that his "player" on the screen meets the ball and sends it back across the net. If he misses, the ball goes off the

screen and he must push the reset button to get the ball in motion again. Hitting the ball, a player can apply "English," to make it veer off in any direction—but, of course, he must keep it in bounds. The speed of the ball is regulated by a master control.

Included in the package are such games as tennis, volleyball, handball, football and baseball, as well as "battleship" and an air-war game, plus a more intellectual adult mathematics game. For the kiddies, there is "haunted house" (the player maneuvers his "ghost-chaser" through the house to flush out the ghost, which flies out of the house when contact is made). There are also educational games and other activities for pre-school children. Odyssey is designed for color and monochrome sets 18 inches and larger.

An accessory converts the TV set into a rifle range. Two targets are supplied—one with stationary prehistoric animals, another with typical shooting-gallery ducks which light up in sequence. A photo-electric rifle is plugged into the control center and the participant fires away at the TV screen. If he hits the target, the light goes out. When he cocks the rifle, the light goes on again, ready for another round. Odyssey will be priced at \$99.95, including the 12-game package. The rifle attachment will be \$29.95. If you want to shoot at your TV set, here's your chance.

RCA's home VTR

RCA has finally revealed details of its upcoming home color cartridge videotape recorder, which it calls Mag-Tape SelectaVision, and is actively seeking to persuade other manufacturers to adopt its system—just as it did two decades ago with color television. It already has had some

success, having licensed Bell & Howell to market a unit for the professional market and Magnavox for the home market. RCA says its SelectaVision record and playback system will be offered on the consumer market in late 1973 as a deck with vhf and uhf tuners for recording off the air and a digital clock-timer for untended recording. "Target price" of the complete deck is \$700.

The major innovation in the RCA system is "in-cartridge scanning." All other videocassette systems announced to date remove the tape from the cartridge to wrap it around the revolving head drum. In the RCA system, a hinged lid at the forward end of the completely enclosed two-reel cartridge is automatically lifted when the cartridge is inserted in the slot in the deck, and the one-piece head wheel enters the cartridge. The head wheel contains four record-playback video heads to scan the three-quarter-inch-wide tape, which moves at three inches per second. The deck is designed to play through any television receiver by attaching it to the antenna terminals. Excellent color and picture quality was observed at a recent demonstration of the new VTR. RCA estimated that a blank cartridge containing enough chromium-dioxide tape to play for one hour would cost about \$30. The system uses two narrow soundtracks, similar to those employed in audio cassette systems, to provide an option of stereophonic sound for pre-recorded musical videotapes when a home stereo system is used along with the television receiver.

Quadraphonic broadcasting

Now that discrete four-channel stereo is available on open-reel tape, eight-track

cartridges and discs (RCA is issuing albums in this format), attention is being focused on the possibility of discrete four-channel FM broadcasting that is compatible with both mono and two-channel stereo receivers. The Electronic Industries Association has established an all-industry National Quadraphonic Radio Committee (NQRC), similar to the National Stereophonic Radio Committee which explored and tested various proposed FM stereo multiplex systems in the 1950s. The new group will look into all aspects of four-channel radio—from technical system specifications to the subjective effects of speaker placement, and eventually is expected to conduct field tests of four-channel transmission systems.

To date, only one four-channel stereo system has been proposed to the FCC. This is the Quadracast system, invented by Lou Dorren and tested by KIOI, San Francisco, which is asking FCC for its adoption as the national standard. The General Electric Company has filed with the FCC field-test reports on a system it has developed, but at press time had not yet formally petitioned for adoption of its own standards. Zenith Radio says it has a system, and several Japanese firms are said to have developed quadraphonic broadcast systems.

Although it may be a long time before the FCC adopts a discrete system, four-channel FM broadcasting is going on right now over at least 100 FM stations. They're using matrix systems, such as CBS's SQ and Electro-Voice's Stereo-4, neither requiring special FCC authorization. The received broadcast may be converted to four-channel using the same decoder used to derive four channels from matrixed stereo records.

by DAVID LACHENBRUCH
CONTRIBUTING EDITOR

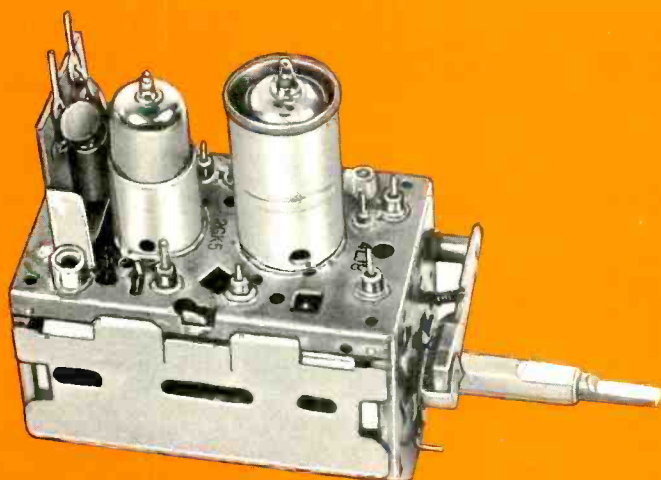

\$9.75

TUNER SERVICE CORPORATION

PROVIDES YOU WITH A COMPLETE SERVICE FOR ALL YOUR TELEVISION TUNER REQUIREMENTS AT ONE PRICE.

TUNER REPAIR

VHF Or UHF Any Type \$9.75.
UHF/VHF Combo \$15.00.

In this price all parts are included. Tubes, transistors, diodes, and nuvistors are charged at cost.

Fast efficient service at our four conveniently located service centers.

1 year guarantee backed up by the largest tuner manufacturer in the U.S.—SARKES TARZIAN, INC.

All tuners are cleaned inside and out, repaired, realigned and air tested.

TUNER REPLACEMENT

Replacement Tuner \$9.75.

This price buys you a complete new tuner built specifically by SARKES TARZIAN INC. for this purpose.

The price is the same for every type of universal replacement tuner.

Specify heater type

Parallel 6.3V
Series 450 mA
Series 600 mA

All shafts have the same length of 12".

Characteristics are:

Memory Fine Tuning
UHF Plug In
Universal Mounting
Hi-Gain Lo-Noise

If you prefer we'll customize this tuner for you. The price will be \$18.25. Send in original tuner for comparison purposes to our office in INDIANAPOLIS, INDIANA.



TUNER SERVICE CORPORATION

FACTORY-SUPERVISED TUNER SERVICE

MIDWEST	817 N. PENNSYLVANIA ST., Indianapolis, Indiana	TEL: 317-632-3493
	(Home Office)	
EAST	547-49 TONNELE AVE., Jersey City, New Jersey	TEL: 201-792-3730
SOUTH	938 GORDON ST., S.W., Atlanta, Georgia	TEL: 404-758-2232
SOUTH-EAST	1505 CYPRESS ST., Tampa, Florida	TEL: 813-253-0324
WEST	SARKES TARZIAN, Inc. TUNER SERVICE DIVISION	
	10654 MAGNOLIA BLVD., North Hollywood, California	TEL: 213-769-2720

Circle 3 on reader service card

new & timely

Computer-diagnosed EKG's in minutes with new service

A new emergency service, *Compu-Gram*, can supply hospitals or clinics with completely diagnosed electrocardiograms in as little as two minutes. According to its developers—Cro-Med Bionics, subsidiary of Chromalloy American Corp.—the emergency service will be especially valuable to hospitals that may not be able to engage a cardiologist or expert EKG reader on a 24-hour basis.

While a tracing of the patient's EKG is being taken, the impulses are also recorded on magnetic tape and transmitted over telephone lines to Cro-Med's computer center in New York. (If necessary, the signals can be transmitted "live," di-

rect from the patient.) Moments later, the computer's analysis comes back to the hospital by telephone or teletype.

For non-emergency cardiology, the EKG's are batch-transmitted once a day, with summaries returned within an hour and a half. The equipment is already in use, and is installed and serviced at no cost to the hospital. Charges are on a per-analysis basis.

Low-loss optical fibers are filled with liquid

A new liquid-filled optical fiber with losses as low as 13.5 dB per kilometer has been demonstrated by scientist Julian Stone of Bell Labs. The fiber is a quartz capillary tube with an outside diameter of

95 microns (millionths of a meter) and an inside diameter of 65 microns. The quartz tubes, have an index of refraction of 1.457 and are filled with tetrachloroethylene (refraction index 1.5).



Losses were measured as less than 20 dB/km between 850 and 860 nanometers (millimicrons) and between 1040 and 1100. Lowest losses were at 1080 nm, where the loss dropped to 13.5 dB/km. (Lowest losses in the latest announced solid optical fibers are in the order of 20 dB/km.; The 840-to-860 and 1040-to-1100 nm bands are considered important because they are especially adapted to use with existing laser oscillators.

Light-carrying fibers with losses of less than 20 dB/km are expected to be useful in long-distance optical transmission systems, which are now the subject of much experiment as possible means of providing spectrum space for the expanding communications of the future.

88,376,245 MHz measured by NBS scientists

The frequency of infrared waves generated by a helium-neon laser has been successfully measured by scientists of the National Bureau of Standards. This is the highest frequency ever measured, and is 100 times higher than any measurement possible up to a few years ago.

Somewhat surprisingly, the measurements are made by the classic "beat" method, heterodyning the signal with a known signal at a lower frequency and measuring the even lower difference frequency. New and extremely stable infrared oscillators developed at the Bureau of Standards Boulder Laboratory make the

(continued on page 12)

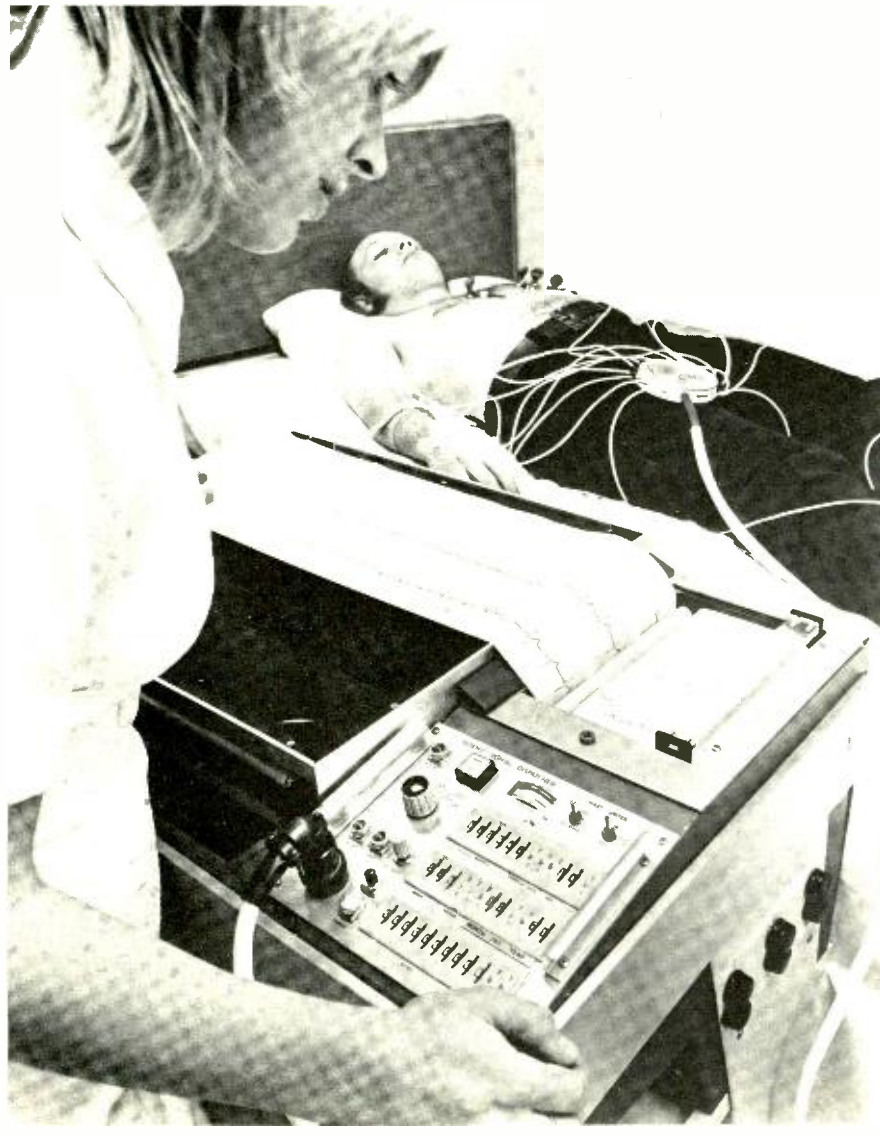

Introducing the expensive dual-trace scope that doesn't cost a lot.

The B&K Precision Model 1470.

A solid-state 5-inch scope that combines dual-trace triggered sweep with vectorscope capability.

Our DC to 10 MHz bandwidth with 10 mV/cm sensitivity makes the 1470 exceptionally versatile. And its TV-H and TV-V positions are a special plus.

Dual-trace lets you observe input and output wave forms simultaneously in the same circuit. And 16-position triggered sweep, from 1 sec/cm to 0.2sec/cm, lets you sync them instantly.

On the other hand, you might prefer our Model 1465 single-trace, triggered-sweep scope at \$359.95. It has many of the same features and our patented CALI-BRAIN® automatic voltage readout system.

Everything about our scopes is expensive — except their price.

For complete technical data, call your local B&K distributor. Or write Dynascan Corporation.

Very good equipment
at a very good price. **B&K**

Product of Dynascan Corporation
1801 West Belle Plaine Avenue, Chicago, Illinois 60613

\$499⁹⁵

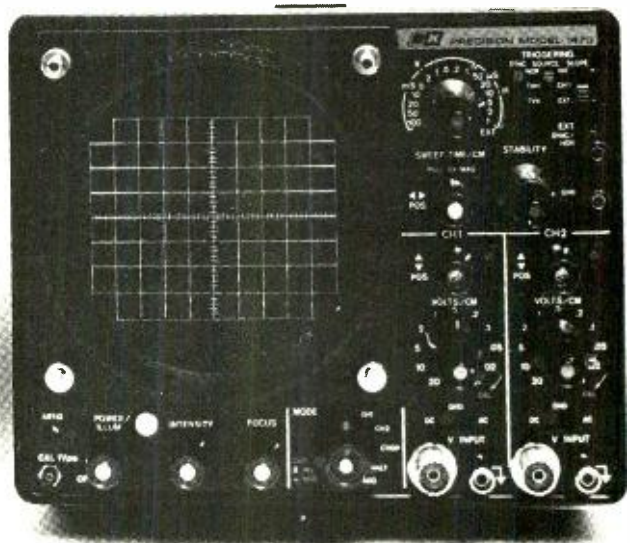

Circle 4 on reader service card

Discover the ease and excitement of learning Electronics with programmed equipment NRI sends you

When you train at home with NRI, you train with your hands as well as your head. You learn the WHY of Electronics, Communications, TV-Radio the NRI pioneering "3-Dimensional" way. NRI training is the result of more than half a century of simplifying, organizing, dramatizing subject matter, and providing personal services unique for a home study school. You get the kind of technical training that gives you priceless confidence as you gain experience equal to many, many months of training on the job.



NRI—The 53 Year Leader in Electronics Training

**APPROVED UNDER
NEW GI BILL** If you served since January 31, 1955, or are in service, check GI line in postage-free card.



*Earn \$5 or more an hour
spare or full time in*
**TV-RADIO
SERVICING**

Color Television has arrived. Sales are soaring, along with the continuing popularity of other home entertainment equipment like portable radios, tape recorders, hi-fi sets, phonographs and auto radios. TV-Radio servicing is one of your best routes to spare-time earnings, a good paying job or a business of your own. NRI not only trains you quickly and expertly, but also shows you how to get started in Servicing soon after you enroll, earning as you learn. NRI trains you in today's methods of installing and repairing all Electronic equipment for the home—including booming Color TV. You even build, experiment with and keep to enjoy your own solid-state radio and your choice of black-and-white or Color TV receiver. Like thousands of others, you can be earning \$5 or more an hour extra in spare time starting soon.

*There's money and
success awaiting you in*
**BROADCASTING—
COMMUNICATIONS**

The experience you gain from intensely practical NRI training in Complete Communications equals as much as two years of training on the job. With NRI, you can train for a choice of careers ranging from mobile, marine and aviation radio to TV broadcasting and space communications. You learn how to install, maintain and operate today's remarkable transmitting and receiving equipment by actually *doing* it. You build and experiment with test equipment, like a VTVM you keep. You build and operate amplifier circuits, transmission line and antenna systems, even build and use a phone-cw transmitter suitable for transmission on the 80-meter amateur band. Whichever of five NRI Communications courses you choose, you prepare for your FCC License exams, and you *must pass your FCC exams or NRI refunds your tuition in full.*

*Move ahead in America's
fast growing industry as*
**ELECTRONICS
TECHNICIAN**

Electronics touches everyone's lives. This vast field of opportunity is open to you with NRI training. Industrial/Military Electronics training—like all NRI courses—prepares you quickly, thoroughly the practical "hands on" way. You build with, and learn to understand the functions of, today's miracle solid-state components like printed circuits, diodes and transistors. You build and experiment with Electronic circuitry used in automation, data processing, ultrasonics, telemetry. Whatever your interest in Electronics, NRI training can fill your needs. Prove to yourself what nearly a million NRI students could tell you . . . that you get more for your money from NRI. Check the postage-free card and mail it today for your FREE NRI Color Catalog. No salesman will call. NATIONAL RADIO INSTITUTE, Electronics Division, Washington, D.C. 20016.

YOU GET MORE FOR YOUR MONEY FROM NRI — Build, test, explore, discover. Everything you see here is included in one NRI course—including Color TV. Other courses equally complete. And you'll be surprised at the low tuition costs. Text for text, kit for kit, dollar for dollar—you get more for your money from NRI.



increased accuracy possible.

The new accurate measurement will—among other things—improve the accuracy of space shots, which depend on an accurate knowledge of the speed of light. That speed, nominally 300 million meters per second, can normally be measured with an error not greater than 10 meters per second. It will now probably be possible to reduce that error to not more than 3 meters per second.

Hugo Gernsback scholarship winner

James Bray, Rockville, Md., is the CREI selectee for the Hugo Gernsback Scholarship Award for 1972. This \$125 award is given annually to a student in each of eight home-study schools of electronics.



Majoring in computers, Jim has maintained a B-plus average with CREI. He has already been able to put his knowledge to work as an employee of Tektronix, Inc., in Rockville. His CREI course, he says, helped him pass his test for employment with Tektronix. Since being employed with the company, it also gave him the needed background and qualifications to move up to a newly created job area—direct customer servicing in the computer field.

In addition to his home study, Jim is a student at Montgomery County Junior College, concentrating in computer science and mathematics. His independent home study has helped his college work, he says, especially in "the development of good learning habits and patterns, which you don't necessarily get from classroom study."

He plans to go on to George Washington University next Fall, as a mathematics major.



Electronic captions for deaf TV viewers?

An adaption of a broadcasting service called TV Time, developed by the National Bureau of Standards to disseminate correct time, may make it possible for deaf TV

viewers to get the audio part of the program via captions on the bottom of the TV screen. A demonstration before 50 deaf TV viewers at Gallaudet College, Washington, was a marked success.

(continued on page 14)

Radio-Electronics is published by Gernsback Publications, Inc. 200 Park Ave. S. New York, N.Y. 10003 (212) 777-6400
President: M. Harvey Gernsback
Secretary: Bertina Baer

ADVERTISING SALES

EAST
Stanley Levitan, Eastern Sales Mgr.
Radio-Electronics
200 Park Ave. South
New York, N.Y. 10003
(212) 777-6400

MIDWEST/Texas/Arkansas/Okla.
Ralph Bergen
The Ralph Bergen Co.
6319 N. Central Ave.
Chicago, Ill. 60646
(312) 792-3646

PACIFIC COAST/Mountain States
Jay Eisenberg
J.E. Publishers Representative Co.,
8560 Sunset Blvd.,
Suite 601,
Los Angeles, Calif. 90069
(213) 659-3810
420 Market St.,
San Francisco, Calif. 94111
(415) 981-4527

SOUTHEAST
E. Lucian Neff Associates
25 Castle Harbor Isle,
Fort Lauderdale, Florida 33308
(305) 566-5656

MOVING?

Don't miss a single copy of **Radio-Electronics**. Give us:

Six weeks' notice

Your old address and zip code

Your new address and zip code

ATTACH LABEL HERE

name (please print)

address

city state zip code

Mail to: Radio-Electronics
SUBSCRIPTION DEPT., BOULDER, COLO.
80302

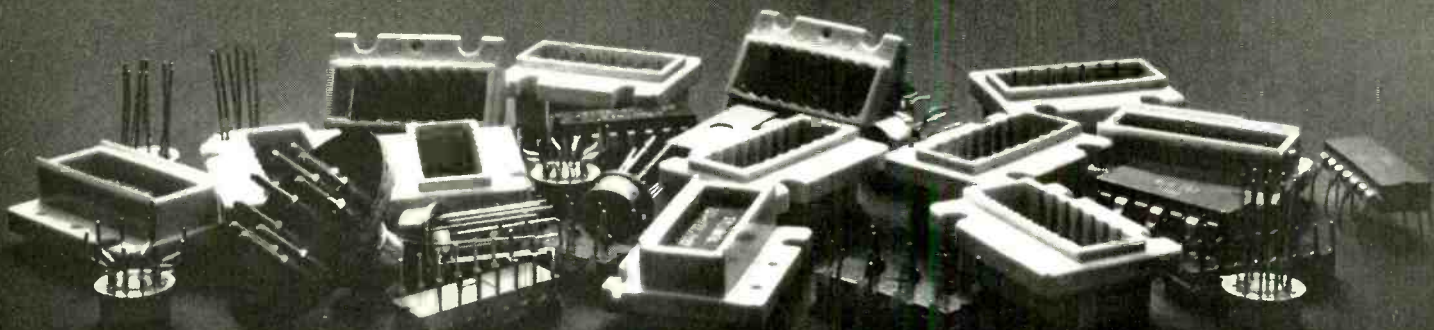

Our 28 ICs replace...

To Be Replaced	IC Replacement	To Be Replaced	IC Replacement
CA3022	713	MC1303A	722
CA3026	723	MC1303B	722
DM-11	709	MC1303C	722
DM-14	718	MC1303D	722
DM-24	719	MC1303E	722
DM-26	721	MC1303F	722
DM-30	721	MC1303G	722
EX4053	722	MC1303H	722
FF274	715	MC1303I	722
FL274	712	MC1303J	722
GE-IC2	712	MC1303K	722
GE-IC3	705A	MC1303L	722
GE-IC4	714	MC1303M	722
GE-IC5	713	MC1303N	722
GE-IC6	715	MC1303O	722
		MC1303P	722
		MC1303Q	722
		MC1303R	722
		MC1303S	722
		MC1303T	722
		MC1303U	722
		MC1303V	722
		MC1303W	722
		MC1303X	722
		MC1303Y	722
		MC1303Z	722
		MC1304A	722
		MC1304B	722
		MC1304C	722
		MC1304D	722
		MC1304E	722
		MC1304F	722
		MC1304G	722
		MC1304H	722
		MC1304I	722
		MC1304J	722
		MC1304K	722
		MC1304L	722
		MC1304M	722
		MC1304N	722
		MC1304O	722
		MC1304P	722
		MC1304Q	722
		MC1304R	722
		MC1304S	722
		MC1304T	722
		MC1304U	722
		MC1304V	722
		MC1304W	722
		MC1304X	722
		MC1304Y	722
		MC1304Z	722
		MC1305A	722
		MC1305B	722
		MC1305C	722
		MC1305D	722
		MC1305E	722
		MC1305F	722
		MC1305G	722
		MC1305H	722
		MC1305I	722
		MC1305J	722
		MC1305K	722
		MC1305L	722
		MC1305M	722
		MC1305N	722
		MC1305O	722
		MC1305P	722
		MC1305Q	722
		MC1305R	722
		MC1305S	722
		MC1305T	722
		MC1305U	722
		MC1305V	722
		MC1305W	722
		MC1305X	722
		MC1305Y	722
		MC1305Z	722
		MC1307A	722
		MC1307B	722
		MC1307C	722
		MC1307D	722
		MC1307E	722
		MC1307F	722
		MC1307G	722
		MC1307H	722
		MC1307I	722
		MC1307J	722
		MC1307K	722
		MC1307L	722
		MC1307M	722
		MC1307N	722
		MC1307O	722
		MC1307P	722
		MC1307Q	722
		MC1307R	722
		MC1307S	722
		MC1307T	722
		MC1307U	722
		MC1307V	722
		MC1307W	722
		MC1307X	722
		MC1307Y	722
		MC1307Z	722
		MC1314G	707
		MC1328G	713
		MC1328P	713
		MC1328PQ	713
		MC1357P	713
		MC1353P	703A
		MFC6010	708
		N5111	708

and hundreds more.

Integrated circuits are still pretty new in TV and stereo equipment.

But Sylvania's ECG Semiconductor program really has those applications pinned down.

Today, just 28 of our ICs will replace over 300 type numbers.

We don't do it by magic, or by offering an "almost as good" replacement.

We do it by assigning our own part number to just one high quality IC that can be used to replace dozens of others.

And to make it easy for you,

we've put together a replacement guide that tells you which of our ICs to use where.

Your customer won't know that you're not carrying 300 different ICs.

All he'll know is that you fixed his set fast, and fixed it right.

The fact that you only needed 28 IC replacements is your secret.

And ours.

In servicing, that can be the secret of success.

Sylvania Electronic Components,
Waltham, Mass. 02154.

GTE SYLVANIA

The weakness of former attempts to bring TV sound to the deaf was that they distracted the viewer with normal hearing. The great advantage of this system is that the viewer can take the captions or leave them. A special module must be installed in the receiver to decode the special signals, which are ignored by the conventional TV circuitry.

While pointing out the possibilities for the hard-of-hearing, the Bureau stresses that the main purpose of the broadcasts is to supply accurate time signals, which can be used to regulate local clocks. Clocks built for the purpose can be kept correct automatically with the signals. (Such a clock will be described in a future issue.)

The cooperation of the local TV station will of course be necessary. The system provides a space for "special messages" which the broadcasters may use for signals that the TV Time module will decode into captions for the program.

Cost of a TV Time receiver module may range from as low as \$20 for the simplest time decoder to about \$50 for modules with numerous options to assist the hearing-handicapped.

Glass waveguides make miniature gas lasers

With hollow glass waveguides—tubes with inner dimensions half the diameter of a pencil lead—Bell Labs scientist Peter Smith has produced miniature gas lasers, about two inches long and twenty thousandths of an inch inside diameter. (The typical gas laser is about the size of a household fluorescent lamp.)

In a gas laser, the gain increases as the diameter of the discharge tube decreases. As the diameter becomes very small, irregularities on the inner wall of the tube tend to block some of the light, offsetting any increase in gain due to the reduction in tube size. The new waveguide laser tubes are made extremely straight, with highly polished inner walls.

Such lasers may possibly be used in tomorrow's optical communications systems. Spaced at intervals along a light path, they could amplify light signals to compensate for transmission losses, much like repeating stations in today's communications networks.

This development must not be confused with the liquid-filled optical fiber

lines, also developed by Bell. The diameters of those fibers are measured in millionths rather than thousandths of an inch.

World's biggest TV screen in New Orleans Superdome

A quasi-cylindrical color TV display consisting of six 40-foot screens is planned for the 80,000-seat New Orleans Superdome sports arena, now under con-



struction. Though it may well be useful for viewing events picked up by television from outside, its chief planned use is to present closed-circuit TV replays of the action taking place in the arena beneath the screen. It can also be used for close-ups, filling the whole screen with action taking place in a small part of the arena.

The 40-foot pictures are produced by the Swiss-invented Eidophor system in which a thin layer of oil is electrostatically distorted by the television signal. Light from an external source beamed through the oil film and onto the screen is modulated in accordance with this distortion and hence with the TV program. The system, known as TNT Supervision, is sold in the United States by TNT Communications, Inc.

Largest radio telescope

The U.S. government proposes to build the world's largest scientific instrument—a radio telescope spread out over a Y-shaped railroad using 39 miles of track in New Mexico.

R-E

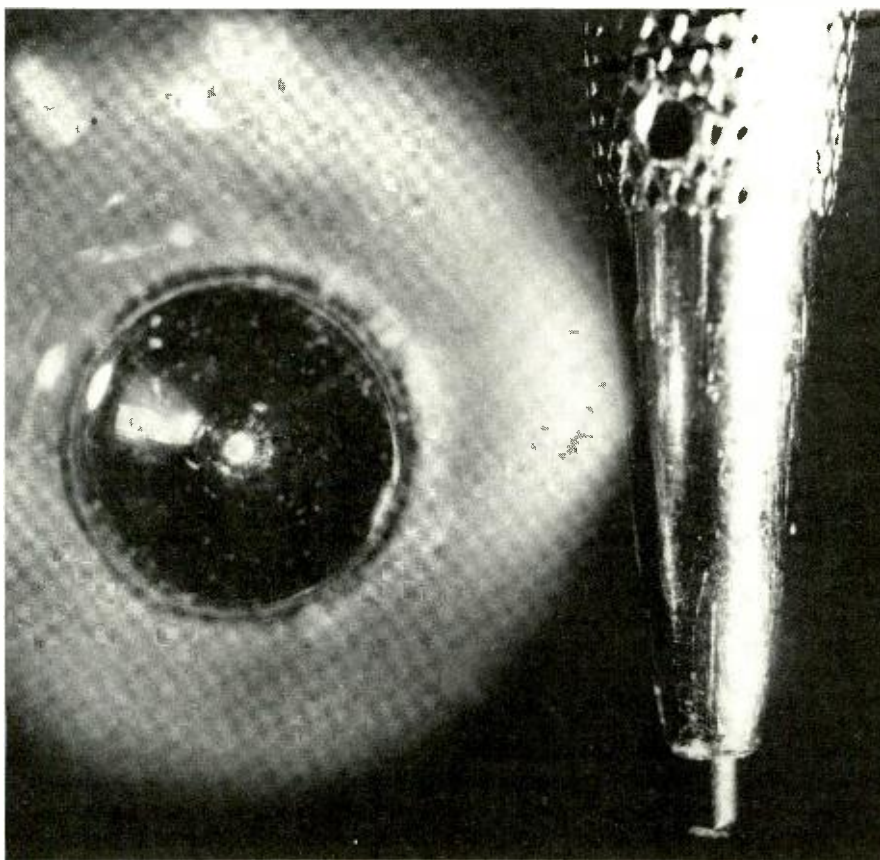



Orange Foam makes the magic difference in Quam Air Suspension speakers.

It's a sensuous sound, rich and mellow—and it's the hottest new item the speaker business has had in years. The wizards at Quam use air suspension construction, dual cones (one's a whizzer!) and perfect the product by using orange foam where lesser speakers have cloth.

Why foam? For durability and long life. For an absolute air seal without lacquer. For consistency in performance and distinctiveness in appearance.

For orange foam speakers with the sensuous sound, take the yellow brick road to your Quam distributor. Quam-Nichols Company, Chicago 60637.

QUAM *The Sensuous Speaker*

Circle 5 on reader service card

letters

SUPPLIERS HAVE HEADACHES TOO

We, a relatively small supplier of high-fidelity kits as others, have suffered a great deal from delays caused by suppliers. For example we recently waited over four months for a supply of switches from a domestic supplier. The problem was created by Underwriters Labs who mistested a switch and ordered Stackpole to cease production and shipping. We find, in addition, that other supposedly off-the-shelf items are being produced in limited production runs rather than tie up capital in inventory.

We have always tried to maintain a liberal stock of all our products and quite a number of our dealers carry substantial amounts dollar-wise. When there are shortages we can only offer projected delivery dates based on information received from our suppliers.

We might offer the following sugges-

tions to buyers of mail order electronics to insure rapid delivery and handling:

1. Include a money order or certified check. If a personal check is enclosed allow up to three weeks for processing and perhaps an additional week for shipping. Our firm has a substantial number of "bad" checks. Consequently, we have been forced to hold shipments until checks clear their respective banks.
2. Print name and address clearly. It is amazing how many nearly illegible orders for merchandise and technical information are received.
3. If additional technical information is required or desired, we always strive to supply it. It is not always possible for us to handle such requests immediately. Often customers have rather thought provoking letters and periodically one of our technicians will try one of

the customer proposed projects.

Perhaps patience is the key. We realize that customers want delivery immediately and wish to receive literature at the same rate. Postal increases have made it difficult for us, as well as other suppliers, to continue to send expensive packets of literature at no charge via first class mail. We now charge a quarter to cover, barely, just the cost of postage. Most suppliers are hesitant to raise prices. In the last three years we have raised prices on perhaps four of our products and these raises have not been consummate with the increase in inflation, the cost of doing business and the dollar devaluation.

In closing, we are always willing to right a wrong, even if the responsibility may not be ours. I think that for the most part, other advertisers react the same way, and I thank you for the opportunity to present our point of view.

(continued on page 23)

INTERNATIONAL Frequency meter FM-2400CH

MOBILE

The FM-2400CH provides an accurate frequency standard for testing and adjustment of mobile transmitters and receivers at predetermined frequencies.

The FM-2400CH with its extended range covers 25 to 1000 MHz. The frequencies can be those of the radio frequency channels of operation and/or the intermediate frequencies of the receiver between 5 MHz and 40 MHz.

Frequency Stability: $\pm .0005\%$ from $+50^\circ$ to $+104^\circ\text{F}$.

Frequency stability with built-in thermometer and temperature corrected charts: $\pm .00025\%$ from $+25^\circ$ to $+125^\circ$ (.000125% special 450 MHz crystals available).

Self-contained in small portable case. Complete solid state circuitry. Rechargeable batteries.

WRITE FOR CATALOG!

- Tests Predetermined Frequencies 25 to 1000 MHz
- Extended Range Covers 950 MHz Band
- Pin Diode Attenuator for Full Range Coverage as Signal Generator
- Measures FM Deviation



FM-2400CH (meter only).....	\$595.00
RF crystals (with temperature correction)	24.00 ea.
RF crystals (less temperature correction)	18.00 ea.
IF crystals.....	catalog price

INTERNATIONAL
CRYSTAL MFG. CO., INC.
10 NO LEE • OKLA. CITY, OKLA. 73102



FREE

Heathkit Catalog Build and save on over 350 kits

Your free 1972 Heathkit catalog describes more kits than ever... over 350...all designed to give you fine performance and save you money when you buy and when you use. Choose solid state color TV, stereo, marine, automotive, test instruments, amateur radio, short-wave, home appliances, and more! Send for your free copy today.

NEW Solid-State Heathkit Color TV — the best TV kit ever offered

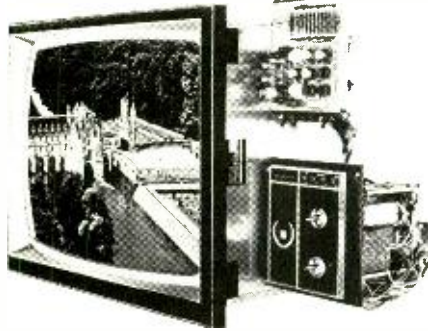

25" diagonal matrix tube, 24-position UHF/VHF detent power tuning, varactor UHF tuner, MOSFET VHF tuner, tint switch. New performance and convenience. Detent tuned UHF & VHF. Preselect any 12 favorite UHF stations, then power pushbutton (or remote) tune all 24 channels in either direction. New angular tint control switch selects normal or wide angle color to reduce tint changes between stations. Exclusive Heath MTX-5 ultra-rectangular black matrix tube has brighter pictures, better contrast. "Instant-On." Automatic fine tuning. Adjustable tone control. Automatic chroma control. Adjustable video peaking. More sensitive tuners. Transformer operated. Built-in dot generator and volt-ohm meter. Choice of cabinet styles from \$81.95*.

Kit GR-900, less cabinet \$599.95*
Kit GRA-900-6, remote control \$79.95*

NEW Heathkit Solid-State Ignition Analyzer

Analyzes standard, transistor, or capacitive discharge systems on 3, 4, 6, or 8 cyl. engines to find bad plugs, points, wiring or distributor parts, incorrect dwell time, coil, condenser, transistor or CD circuitry problems. Built-in tach, 0-1000 & 0-5000 rpm ranges for carb. adjustments. Constant width patterns, primary or secondary, parade or superimposed, plus expanded. Optional 12VDC supply for road checks, \$24.95*.

Kit CO-1015 \$129.95*

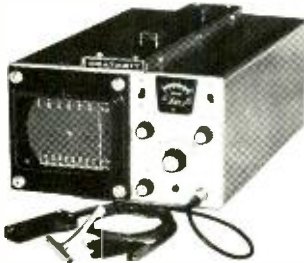

NEW Heathkit 8-Digit Calculator

Adds, subtracts, multiplies, divides, chain or mixed functions, and constant. Floating or selectable 7 position decimal. Plus, minus, and overflow indicators. Overflow protection of most significant 8 digits. Clear-display key to correct last entry. Standard keyboard. American LSI circuitry. Bright 1/2" red digits. 120 or 240 VAC operation. Desktop black & white cabinet, 3 1/2" h x 6" w x 10 1/4" d.

Kit IC-2008 \$129.95*



NEW Heathkit Digital FM Tuner

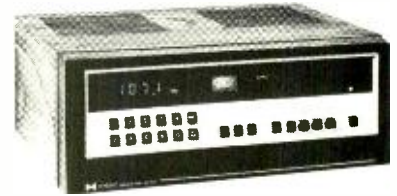

Another Heathkit "first" in consumer electronics. Pure digital computer design including digital frequency synthesizer tuning employing phase-lock-loop techniques, FET varactor FM RF front end, digital discriminator and readout result in performance specs and tuning convenience that already are the talk of the audio world: channel frequency accuracy better than 0.005%; less than 1.8 uV sensitivity; distortion levels of 0.1%; selectivity and IF rejection better than 95 dB; image & spurious rejection better than 90 dB; S/N ratio better than 65 dB; separation better than 40 dB. One of a kind, the AJ-1510 "computer tuner" is the only tuner offering you 3 distinct tuning modes; keyboard, computer-type punch cards (up to 3), plus automatic band scanning with variable speed and stereo-only capability. The 55 ICs, 50 transistors and 50 signal diodes mount on 10 modules with 7 plugging into a master board for optimum computer modularity & ease of assembly. Join the computer generation of audio equipment — order your AJ-1510 today.

Kit AJ-1510, tuner only \$539.95*
Cabinet \$24.95*

NEW Heathkit 4-Channel Amplifier

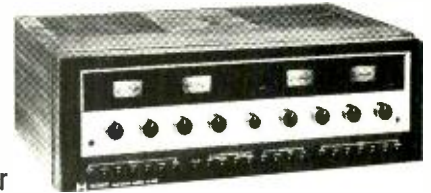

Brings you 200 versatile watts for discrete or matrixed 4-channel sound, and stereo or mono. Built-in matrix circuitry decodes matrixed 4-channel recordings or broadcasts, lets you use your existing stereo equipment as well as enhancing your present stereo records and tapes. As discrete 4-channel media grows the AA-2004 is ready... with four amplifiers producing 260 watts into 4 ohms (4x65), 200 watts into 8 ohms (4x50), 120 watts into 16 ohms (4x30), and controls for every source, mode and installation. Amplifier sections are controlled in pairs with one complete stereo system for left and right front speakers and another for left and right rear — so it can be used to power two complete 4-channel systems (up to 8 speakers)... or, four separate-source mono systems if desired. Easy circuit board assembly.

Kit AA-2004, amplifier only \$349.95*
Cabinet \$24.95*

NEW Heathkit Solid-State FET VOM

Dual FET portable multimeter with lab grade accuracy, 10 megohm input and the ranges you really need. 9 DCV & ACV ranges, 0.1 to 1000 v, ± 2% accuracy. 6 DC & AC current ranges, 10 microamps. to 1 amp. 7 resistance ranges, X1 (10 ohm center) to X1Meg. 9 dB ranges, —40 to + 62. 1% precision metal-film dividers. 4 1/2", 100 uA, ruggedized tauband meter, diode & fuse protected. Battery check.

Kit IM-104, less batteries, \$79.95*.

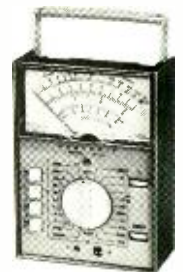

See them all at your Heathkit Electronic Center...or fill out the coupon below

HEATHKIT ELECTRONIC CENTERS — ARIZ.: Phoenix, 2727 W. Indian School Rd.; CALIF.: Anaheim, 330 E. Ball Rd.; El Cerrito, 6000 Potrero Ave.; Los Angeles, 2309 S. Flower St.; Pomona, 1555 Orange Grove Ave. N.; Redwood City, 2001 Middlefield Rd.; San Diego (La Mesa), 8363 Center Dr.; Woodland Hills, 22504 Ventura Blvd.; COLO.: Denver, 5940 W. 38th Ave.; FLA.: Miami (Hialeah), 4705 W. 16th Ave.; GA.: Atlanta, 5285 Roswell Rd.; ILL.: Chicago, 3462-66 W. Devon Ave.; MD.: Rockville, 5542 Nicholson Lane; MASS.: Boston (Wellesley), 165 Worcester St.; MICH.: Detroit, 18645 P. Eight Mile Rd. & 18149 E. Eight Mile Rd.; MINN.: Minneapolis (Hopkins), 101 Shady Oak Rd.; MO.: St. Louis, 9296 Gravois Ave.; N.J.: Fair Lawn, 35-07 Broadway (Rte. 4); N.Y.: Buffalo (Amherst), 3476 Sheridan Dr.; New York, 35 W. 45th St.; Jericho, L.I., 15 Jericho Turnpike; Rochester, Long Ridge Plaza; OHIO: Cincinnati (Woodlawn), 10133 Springfield Pike; Cleveland, 5444 Pearl Rd.; PA.: Philadelphia, 6318 Roosevelt Blvd.; Pittsburgh, 3482 Wm. Penn Hwy.; TEXAS: Dallas, 2715 Ross Ave.; Houston, 3705 Westheimer; WASH.: Seattle, 2221 Third Ave.; WIS.: Milwaukee, 5215 Fond du Lac.

HEATHKIT Schlumberger	
HEATH COMPANY, Dept. 20-7 Benton Harbor, Michigan 49022	
<input type="checkbox"/> Please send FREE Heathkit Catalog.	
<input type="checkbox"/> Enclosed is \$ _____, plus shipping.	
Please send model(s) _____	
Name _____	
Address _____	
City _____	State _____ Zip _____
Prices & specifications subject to change without notice. *Mail order prices; F.O.B. factory.	
CL-434	

Circle 100 on reader service card

“At ComSonics we encourage all our technicians and engineers to enroll with CREI. Know why?”

WARREN BRAUN, *President, ComSonics Inc., Virginia Engineer Of The Year, ASE International Award Winner, CREI Graduate*

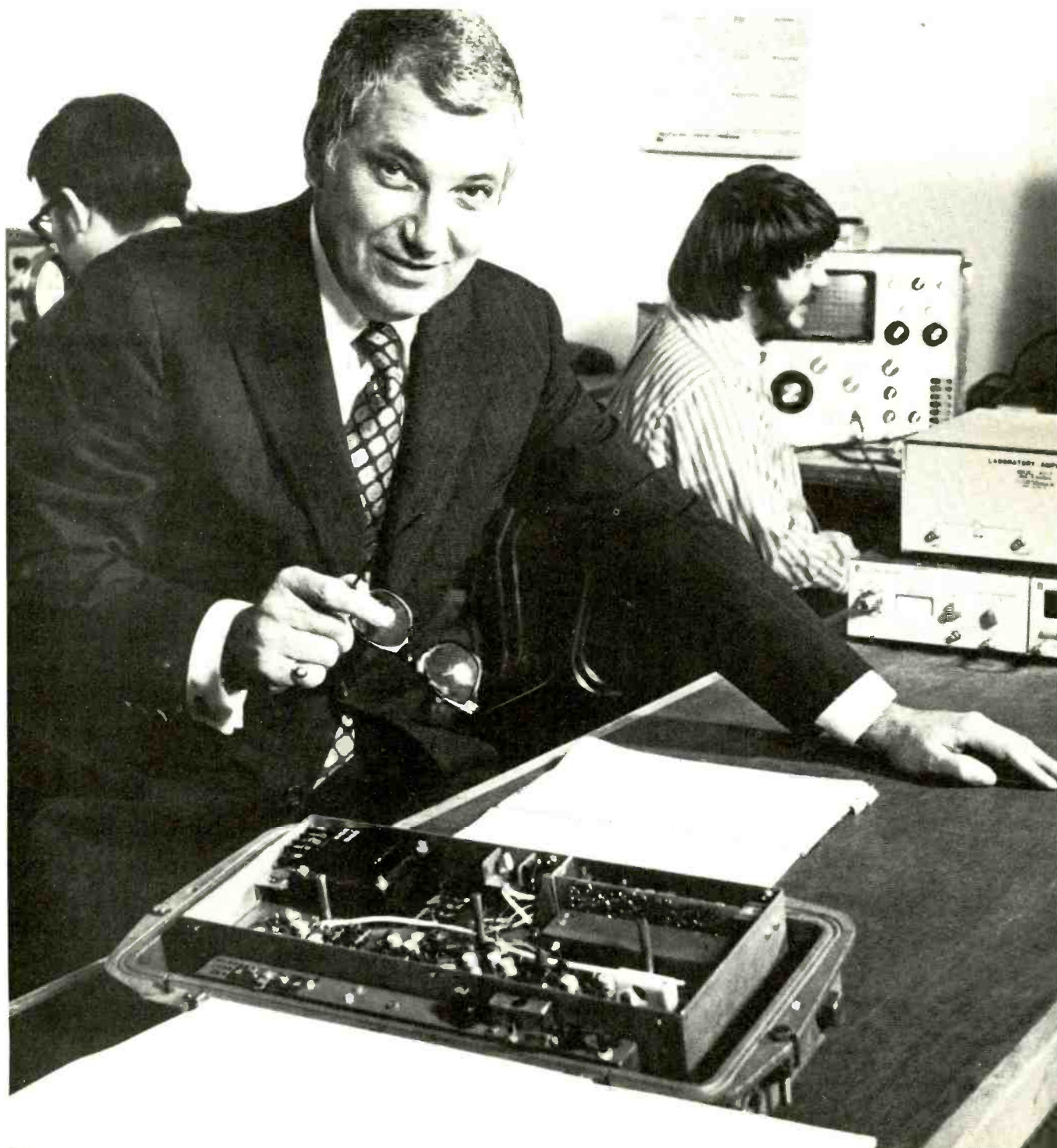



"As a CREI graduate myself, I know the advantages of their home-study programs. CREI education has proven an excellent tool of continuing education for our employees and for me. And I strongly believe in CREI's ability to teach a man to learn independently and to use reference materials on his own.

"As President of ComSonics, I see changes taking place in our Electronics business every day. We're in closed circuit TV and acoustical engineering...and pioneered in Cable TV. CREI gives my men the knowledge they need to work in new areas...CREI's new course in Cable TV is an example. The CATV industry is expected to grow 250% in the next three years. I know the opportunities in Cable TV. I designed one of the first CATV systems in 1950. But technical advances are constantly changing the field. And since CREI's experts know most of what's going on in all areas of Electronics, I know that CREI can give my men some of the important, specialized training they'll need to maintain our position in Cable TV and our reputation in Electronics.

"We've interviewed many technicians and engineers for jobs in the past year and had to reject them because their knowledge is archaic and out-of-date. A man is of no value to us if he doesn't keep up-to-date."

Some of the biggest names in electronics buy CREI courses for their own employees. CREI students and graduates prove themselves on the job. They move ahead of the pack by earning promotions and salary increases.

The Future Belongs To You

You've been in Electronics long enough to know that the field is changing more rapidly than ever. New industries, like Cable TV, are born almost overnight. But surveys show that three out of four men now working in Electronics aren't technically qualified to work in these new areas. Clearly, the future will belong to the man who gets the right education *now*.

Start Learning At Home

But what you learn depends on which school you choose. Here's why CREI is among the best.

With the CREI program you study at home. At your own pace. There are no classes to miss, no work to make up. Each lesson is explained in clear, easy-to-read language. That's why many men do far better in home study than they ever did in school...even if they've been out of school for years. And the study habits they learn from CREI are sustained through life.

As a CREI student, you'll be assigned to an experienced instructor who will grade your assignments and offer constructive comments and criticism. If there's a special problem, the instructor will work with you until you understand it fully. You'll receive personal attention from your instructor because he deals with each student individually—as a class of one.

What Will I Learn?

You'll be learning the latest in advanced technology, geared to specific industry programs. Both theory and practical material are presented to meet all phases of job-related training needs.

CREI courses are written for the man who knows basic Electronics, but whose advancement depends on keeping his technical know-how current. You choose what you want to learn. You study subjects which help you grow and advance

in your present job and which relate to your career objectives. CREI offers you the opportunity to continue your education throughout your working life.

Constantly Up-Dated Courses

Because of rapid changes in Electronics, CREI courses are constantly being revised and up-dated by professionals who work in Electronics every day. New developments are included as quickly as they occur. Right now, CREI students are getting the latest up-to-the-minute information on such things as Cable TV, LSI chips, microminiaturization, lasers and masers, telemetry systems, servomechanisms, and data links. If it's new in electronics, CREI—and you—will know about it!

Developed By Top Scientists And Engineers

CREI maintains a full-time advisory faculty of some of the top names in Electronics. Each is a specialist in his own field, an expert who plans and develops CREI lesson material. After each expert submits his course plan, it is carefully reviewed and written by the CREI educational staff. Then each course is broken down into individual lessons. And they make certain each lesson is clear and self-explanatory. Just the right length for easy understanding and effective study.

How Can I Qualify?

If you've read this far, your interest in getting ahead in Electronics is evident. Send for our famous book on how to prepare for tomorrow's jobs in Electronics—the book that has helped thousands of men just like you get ahead. For your free copy, simply mail postpaid card today.



Founded 1927

Accredited Member of the National Home Study Council

Free book tells you all about CREI programs. For your copy, mail coupon, postpaid card or write: CREI, Dept. E1407C, 3939 Wisconsin Avenue, Washington, D.C. 20016

CREI, A Division of the McGraw-Hill Continuing Education Company
Dept. E1407C, 3939 Wisconsin Ave., Washington, D.C. 20016

Please mail me free book describing CREI Programs.

I am interested in: College Credits for CREI Study
 Space Electronics Electronic Engineering Technology
 Computers Industrial Electronics Nuclear Engineering Technology Electronics Systems Engineering
 Nontechnical Course in Computer Programming
 CATV Engineering

Name _____ Age _____

Address _____

City _____ State _____ Zip Code _____

Employed by _____

Type of Present Work _____ G I Bill _____

APPROVED FOR TRAINING UNDER NEW G.I. BILL



AUDIO COMPRESSORS

THE VERSATILE ONES!



MODEL ACA-1

\$49.95 KIT

Assembled
\$69.95

MODEL ACA-1 AUDIO COMPRESSOR maintains constant output level with 45 DB input level change ■ Flat 20-20,000 Hz response ■ Extremely low harmonic distortion ■ Front panel compression meter and in/out switch ■ Easily installed in mike line ■ 110-volt a.c. or 12-volt d.c. operation ■ Only 5" W x 2¼" H x 4½" D.



MODEL ACP-1

\$24.95 KIT

Assembled
\$34.95

MODEL ACP-1 COMPRESSOR-PREAMP features 30 DB compression range ■ Flat 20-20,000 Hz response and low harmonic distortion ■ Easily installed in mike line ■ 9-volt battery operation ■ Only 4" W x 2½" H x 3½" D.

IDEAL FOR:

✓ **TAPE RECORDERS**... Automatically control recording level. Achieve professional results with little effort. Ideal for music, lectures, family gatherings. Used by recording studios, schools, radio and TV stations.

✓ **ELECTRIC GUITARS**... Add Exciting new sound with sustainer action from compressor on musical notes. Enhances effect of wa-wa, fuzz, and reverb. Used by many well-known rhythm groups.

✓ **TRANSMITTERS**... Improve performance of amateur radio and CB transmitters with increased talk power. Push-to-talk line included in both units.

✓ **P.A. SYSTEMS**... Automatically compensates for different voice levels. Maintains constant output volume and reduces annoying feedback.

STANDARD-TIME RECEIVER



MODEL STR-1

\$74.95 KIT

Assembled
\$99.95

Crystal-controlled 5, 10 & 15 MHz WWV receiver ■ 0.25 microvolt sensitivity ■ Telescoping antenna and built-in speaker ■ Complete with all crystals ■ Compact size only 4½" W x 2¼" H x 5½" D.

Send check or money order, plus \$1.50 for shipping anywhere in U.S.A. California residents add 5% sales tax.

DEALER INQUIRIES INVITED



CARINGELLA ELECTRONICS, INC.
P.O. Box 327 □ Upland, California 91786
Phone 714-985-1540

Circle 6 on reader service card

appliance clinic

THE GROUND-FAULT-INTERRUPTER

by JACK DARR
SERVICE EDITOR

THERE IS A NEW SAFETY DEVICE ON the market. Not new, in the sense of having just been invented, but certainly not commonly known. It is the "Ground-Fault-Interrupter". For a test, I asked several electricians what it was, and the majority answer was "Huh?" One power-company engineer told me that he had one, at the sub-station. True, they have been used for quite a while there, in heavy-duty types. (Another one said "Ground-Fault Interrupter? Some kind of electronic thing to prevent earthquakes?" I told him that the San Andreas Fault was *not* the kind of *ground-fault* I meant!) Seriously speaking, this device is *not* well-known as yet, although the 1971 National Electrical Code specifies its use in certain locations!

The Ground-Fault Interrupter (or *gfi* from now on) is a dual-purpose, very sensitive, extremely fast-acting circuit-breaker. It provides the same over-current protection as the regular circuit-breakers. In addition, it can sense very minute ground-fault currents. These are the type of currents which flow whenever a leakage or short to ground occurs. For one example, a person touching the hot wire while standing on a grounded surface.

A conventional circuit-breaker, of course, will not open the circuit when this type of fault occurs. A *gfi* will. Not only this, it will do it so fast that it can save the person from electrocution! Let's see how this is done. A bit of history first.

Gfi's have been in use in power stations for a long time. They trip at 20-40 amperes, which is OK for that kind of service. Smaller, more sensitive units were developed, and used, in Europe several years ago. However, by US standards, these were considered marginal, in speed and current-limiting. So, we went to work to make them faster and thus safer.

As many experiments have established, it takes something like 15-20 milliamperes of current through the human body to cause ventricular fibrillation of the heart (interruption of its normal rhythm, so that it flutters wildly

instead of beating). This is measured through the most likely path "arm to leg" so that the shock currents pass through the chest region. This is also very close to the "let-go" threshold—the current-value above which the muscles contract and you can't let go of the wire. You freeze to it, and without protection, you have had it.

This was the objection to the French and Austrian versions of the *gfi*. Their trip value was up around 30 mA, considered to be far too high for maximum protection. So, US engineers went to work to speed it up, and they did. Typical ratings for production *gfis* are now down to a sensitivity of 5.0 mA, and the trip time has been reduced to 0.025 seconds! That's 25 ms.

To clear up one point before we go any farther, the *gfi* *does not limit the current* that can flow through the fault. It limits the time during which it can flow. So the total energy fed through the fault (human body, or whatever else) is limited, by limiting the pulse width.

Now, how does it do this? The *gfi* contains standard circuit-breakers that will open if the load current exceeds their trip-ratings. These are electrically operated, by a coil—something like the large "contactors" used in industrial electrical work. A fault-current energizes the coil, and opens the circuit very quickly. This refers to the normal load-current flowing in the circuit.

Beside these, the *gfi* contains a sensing circuit that can detect very small currents flowing *from the line to ground*. Normal load currents flow up one side and down the other as in Fig. 1. If we have 2.0 amperes going one way in wire A, we'd have the same 2.0 amps going the other way in wire B. The circuit is *balanced*. To verify this, take the standard clamp-on ac ammeter, and hook it around only one wire—you get a reading. The same with the other wire. Now hook it around both wires at once—no reading, because the line is balanced.

That's how the *gfi* gets its information as to when to trip! The two (or three) "circuit wires" are run through a differential transformer, Fig. 2. A sensor

(continued on page 84)

LETTERS

(continued from page 16)

Rather than bring one particular advertiser to the attention of our readers, we are keeping this letter anonymous as its contents really apply to many mail-order sellers. However, should any reader encounter difficulty in obtaining the merchandise he has ordered, please let us know.—Editor

DON'T CHANGE IT!

In your April, 1972 issue, you solicited comments on Trudye Connolly's "Womens Lib" diatribe, limiting your request for responses to "women readers." I shall overlook this lack of judgement on your part, and reply anyway.

There has never been any restriction on my reading an article in "Womens Day" or "Ladies Home Journal" if I chose to. However, I should expect to be hauled away in a straightjacket if I ever wrote to their editors demanding that their titles be changed to "Peoples Day" or "Citizens Home Journal."

Open your pages to pressure groups and you can no longer differentiate between the sane and the insane. After the Sexists, welcome the Racists to your pages: You do an article on "White Noise Generators," then you must run one on "Black Noise Generators." Don't forget free reprints of all articles in the first 72 "Minority Languages" that come to someone's head. Then will come the Gay Liberation groups to your hallowed scientific pages: no published Nomograms without accompanying Homograms! How about only ac-dc circuits for Bisexuals?

It was a mistake to ever change cycles per second to HERTZ. We would be better off with H1Stz.

JOSEF SCHOENBRUN,
Santa Monica, Calif.

R-E

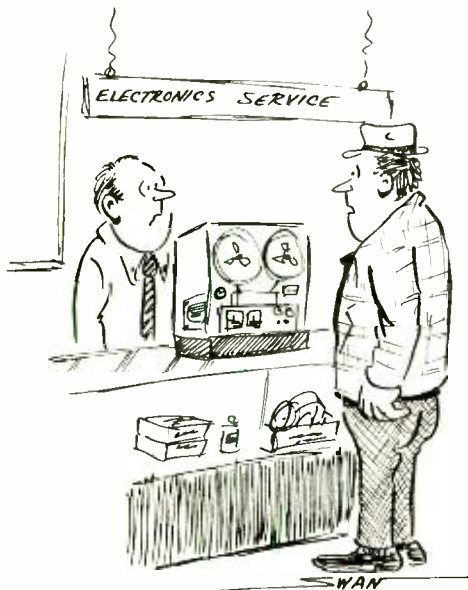

Since you put in the Japanese transistors it keeps getting the R's and L's mixed.



~~\$795~~
~~\$395.50~~
NOW, \$247.50

WHILE THEY LAST.

GE VIDEO TAPE RECORDERS

(Built by Sony for General Electric)

We have only 100 left and they're available on a first-come, first-serve basis. Here's what you get

- Brand new, fully guaranteed GE 1/2-inch VTRs in original factory cartons.
- Compatible with all Sony CV Series 1/2-inch video tape recorders, including battery operated portable (DVK-2400).
- Tapes programs picked up by TV cameras or off-the-air using Sony monitor and plays them back
- A video and audio tape recorder for the price you'd expect to pay for a good audio tape recorder.
- Can be used for educational TV, training, instructions, advertising and sales presentations, instant home movies.
- Top value, sold originally by GE for \$795. GBC has sold more than 3,000. An outstanding bargain while they last (in handsome, walnut cabinet). \$247.50.
- Portable model/vinyl clad case — \$279.50.

LATEST BRAND NEW SONY 1/2" VIDEO TAPE

	Regular Price	Sale Price
V-30H—30 min. playing time for battery portables	\$21.95	\$14.97
V-31 — 30 min. playing time	\$21.95	\$14.97
V-32 — 60 min. playing time	\$39.95	\$24.97

TERMS: 25% deposit/balance C O D /Shipped F O B . N Y C .
Check with order FREE (\$10 value) Sony Head Cleaning Kit



GBC Closed Circuit T.V. Corp., 74 Fifth Ave., New York, N.Y. 10011. (212) 989-4433.

Circle 7 on reader service card

IT'S EASY TO ASSEMBLE A SCHOBER ORGAN!

*Includes easy to assemble walnut console kit. (Only \$1575 if you build your own console.) Amplifier, speaker system, optional accessories extra.

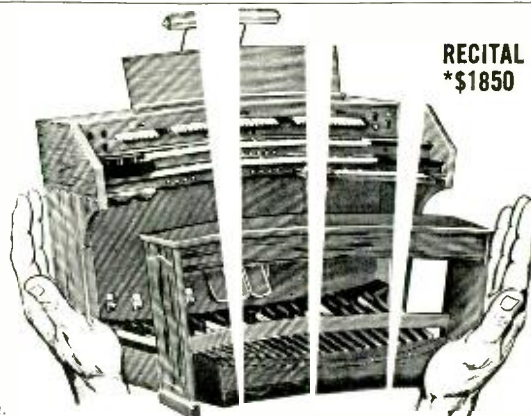

You couldn't touch an organ like this in a store for less than \$4,000 — and there never has been an electronic instrument with this vast variety of genuine pipe-organ voices that you can add to and change any time you like! If you've dreamed of the sound of a large pipe organ in your own home, if you're looking for an organ for your church, you'll be more thrilled and happy with a Schober Recital Organ than you could possibly imagine — kit or no kit.

You can learn to play it—and a full-size, full-facility instrument is easier to learn on than any cut-down "home" model. And you can build it, from Schober Kits, world famous for ease of assembly without the slightest knowledge of electronics or music, for design and parts quality from the

ground up, and — above all — for the highest praise from musicians everywhere.

Send right now for the full-color Schober catalog, containing specifications of all five Schober Organ models, beginning at \$499.50. No charge, no obligation. If you like music, you owe yourself a Schober Organ!

The Schober Organ Corp., Dept. RE-104
43 West 61st Street, New York, N.Y. 10023

Please send me Schober Organ Catalog and free 7-inch "sampler" record.

Enclosed please find \$1.00 for 12-inch L.P. record of Schober Organ music.

NAME _____

ADDRESS _____

CITY _____ STATE _____ ZIP _____

Circle 8 on reader service card

for better stereo use

Test tapes are vital if you want to get the best possible performance from your tape player. They're an inexpensive way to do a final "tune-up" on your mag-tape machine.



TEST TAPES AND

by PETER E. SUTHEIM

TEST RECORDS AND TAPES PROVIDE the only way to make comprehensive checks and measurements on record players and tape recorders (or tape players). They can also be sources of signals to test every other part of your system, from preamp to loudspeaker.

For various reasons (some logical and some not) test records are usually more elaborate than test tapes, and offer a greater variety of signals. This means that you can make more kinds of tests on a system with a record player than on one that has only a tape recorder (or player).

What is azimuth?

The most important signal on a test tape is the one for *azimuth alignment*—and azimuth alignment is the main reason for using a test tape. Azimuth is the angle that the gaps in the playback and record heads make with respect to the direction of tape travel. For tapes to be interchangeable among machines, that angle must be exactly 90°. The magnetic pattern recorded on the tape is oriented as shown in Fig. 1 when the record-head gap is exactly perpendicular to the direction of tape travel.

If the playback-head gap is tilted one way or the other, it "bridges" a wider space on the tape than when it is perfectly vertical. This cancels—partially or completely—some frequencies in the upper part of the audio range (where the alternating north and south magnetizations are close together). As a result, high-frequency response can be noticeably degraded, giving the sound a muffled or fuzzy quality. (A dirty or worn playback head can produce the same symptoms, which then aren't eliminated

by azimuth alignment.)

If your recorder uses a single head for record and playback, its azimuth alignment can be off by several degrees and tapes will sound fine as long as you play only tapes that were recorded on your own machine, with the head misaligned the same for recording and playback. Commercially recorded tapes or tapes made on any other recorder with a different azimuth angle will sound bad. On a machine with separate record and play heads, the gaps in the two heads must be mutually aligned, if tapes recorded and played on that machine are to sound good. So clearly the most logical approach is to standardize on perpendicular, or 90°, azimuth.

Every recorder has a small screw near each head for making this adjustment. The exact appearance and location of the screw differ from machine to machine, so consult the instructions for your make and model.

How to align

Before using any test tape, clean and demagnetize all the heads (erase heads don't need demagnetizing). The azimuth alignment signal is usually the

first or second signal on the tape. It is a pure high-frequency tone, at least 7,500 Hz (sometimes 6,000 for cassettes), but it can be as high as 15,000 Hz. While it plays, observe the level meter, if it operates during playback, and turn the playback-head azimuth adjustment screw slowly one way and then the other until the meter reads a maximum. If you have no built-in meter or other playback-level indication, a small flashlight lamp connected across the speaker terminals will give a relative level indication.

It should not be necessary to turn the azimuth screw more than about a half turn or so. If you cannot get a maximum in that range, you're turning the wrong screw, or the head is grossly misaligned or very badly worn. The maximum should be quite distinct, especially if the test-tape frequency is 10,000 Hz or higher. It will be less distinct (and the adjustment therefore less critical) with narrow-track formats—quarter-track stereo, eight-track cartridge, cassettes, etc.

Once the playback-head azimuth is established, it can be used to align the record head, by recording a 10-kHz sig-

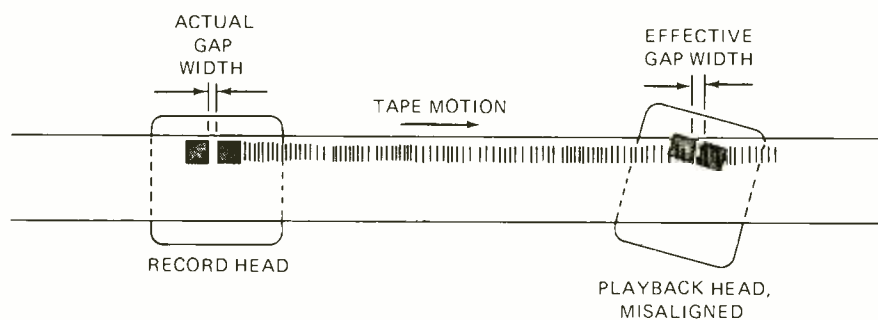

FIG. 1—EFFECT OF MISALIGNED HEAD. Tapes (unless recorded and played by the same head) are distorted. Increase in effective gap width lowers top of the high-frequency range.



Test records play an important role in checking out your changer or turntable. Take a look at what's available and how you can use them to improve the performance of your stereo system.

TEST RECORDS

nal while watching the VU meter switched to playback and adjusting the record azimuth screw for a maximum. Of course, if your machine has only a single head for both record and play, no separate adjustment is necessary for record azimuth.

Using the audio tones

The rest of the tones on a test tape are usually an assortment of frequencies spanning the audio range. For example, the Ampex series of tapes begins with a 700-Hz reference tone recorded 10 dB below normal operating level, and follows that with 15 kHz (also used for azimuth alignment), 12 kHz, 10 kHz and so on down in reasonable intervals to 50 Hz. Each tone is 10 seconds long, and each (one assumes) has been recorded at exactly the same level as every other (10 dB below operating level). So, by watching the VU meter as the tape plays through, you can measure the frequency response of the playback head and electronics of your tape machine.

By connecting a meter across the speaker terminals of your amplifier, you can get an idea of the frequency response of your whole system. (A vtvm or transistor multimeter is best for this job—some vom's, especially cheap ones, are inaccurate at high audio frequencies.) Such a test may not be terribly meaningful unless you disconnect your speaker and replace it with dummy load of about equivalent resistance (and preferably noninductive). Most speakers have a shockingly erratic frequency response curve, and their impedance can change wildly with frequency also. That can result in sizable variations in meter readings from one test tone to the next, variations which

may or may not be audible. Sometimes just an ear check is more valid than meter readings, because if deviations from flat response aren't audible, they aren't audible, so who cares?

You are part of the system

If you listen to the test tones to gauge the quality of your system, remember that the ear's sensitivity falls off drastically at low frequencies and low volumes, and somewhat also at very high frequencies. Unless you play all the tones very loud, a 50-cycle (Hz) tone will sound much softer than a 100-Hz tone, even though the speaker may be producing the same sound pressure at both frequencies. That's a normal quirk of the ears you were born with, and recognition of that fact led to things like loudness controls, which are intended to compensate for the effect and allow more naturally balanced sound at lower-than-original volume levels.

Also, depending on your age, sex and history of exposure to certain kinds of noise, your ability to hear high frequencies can be very much diminished. After almost a decade of adult life in New York City, riding subways just about every day and walking amidst construction noises and auto horns, I can hear almost nothing above 13 kHz, and the upper limit has fallen somewhat in just the past year or so. Continued exposure to high noise levels (above 85 dB sound-pressure level), especially noises that contain a lot of energy above 1,000 Hz, is definitely and permanently destructive to hearing.

In fact, there is some evidence to suggest that the often-cited loss of hearing with age that occurs much more commonly in men than in women is probably because men are more likely

to have been exposed to continuous high noise levels (as in factories, quarries, construction jobs, for example) than women are, and not nearly so much due to secondary sex characteristics (like baldness). But the issue of noise pollution is a subject for at least another whole article.

Special signals—flutter and wow

So back to test tapes. The Audiotex tapes have, besides the discrete tones, a continuous sweep from 10 kHz down to 30 Hz, which is more useful than single tones for finding narrow peaks or dips in system response. With a sweep tone, you can also pinpoint speaker or listening-room resonances.

Some test tapes also provide a tone especially intended for checking flutter or wow. *Flutter* is a rapid usually periodic variation in tape speed; if it's as low as about 10 cycles per second it contributes a warbly, wavery quality to certain kinds of music (it is usually not nearly so audible on speech). If it's faster than that, it may be difficult for an untrained ear to distinguish it from harmonic or intermodulation distortion. The sound is simply "unclean", or fuzzy.

Wow is a substantially slower speed variation—usually once per revolution of the pinch roller, tape reel, cassette hub, etc. It sounds like a regular rising and falling of pitch. It is, like flutter, least audible on speech or on rapid, thick-textured music.

A flutter or wow test tone is nothing more than a 3-kHz tone recorded at normal level. The center of the most sensitive range of human hearing is around 3 kHz; pitch and loudness variations can be most easily detected in that range. If your test tape has such a tone,

you might try comparing that tone with one of the same pitch from an audio oscillator (which of course will be almost perfectly pure). Comparing the tones should help you pinpoint flutter or wow.

Some people prefer to check for wow and flutter with soft, relatively slow piano or guitar music instead of a tone. Those two instruments seem to be most susceptible to "souring" by speed variations. A pure tone is sometimes an excessively severe test, since you'll never be listening to pure tones for fun. If you can't hear any flutter or wow on piano music, you won't be likely to hear it on anything else. The Audiotex 30-214 tape has piano chords for just that purpose.

The Audiotex test tape (GC Electronics) is the only one we know of that includes recorded material for checking distortion. Information for using that part of the tape is included with it. A harmonic distortion meter is not necessary for making subjective checks. Of course, if you want to *measure* distortion, you will need a suitable meter.

Measuring harmonic distortion on a tape with an instrument that nulls sharply can be frustrating, because the slightest wow or flutter will pull the fundamental tone on the tape out of the null and so give a higher reading than you should get. (Incidentally, harmonic distortion on tape recorded at normal level can run 3% or more on some machines, putting it a factor of 10 or more above the distortion you get from amplifiers. Something to keep in mind.)

The Audiotex tape also offers means for checking channel balance and channel separation. The first gives you a way of setting left and right channels for equal loudness; the second lets you see how much of a tone recorded on one channel is audible in the other.

Cassette and cartridge tapes

Cassettes and cartridges offer some special problems. The stereo cassette and the 8-track cartridge have exceptionally narrow and close-together tracks, making vertical head alignment crucial. The only test cartridge we have been able to find that offers means for checking *track* alignment is sold under the name "Dr. Tape" (Specialty Sounds, Inc., 33490 Groesbeck Hwy., Fraser, Michigan 48026). It is type X8-HA (\$2.98 suggested list). This is for 8-track units only. So far, no suitable cassette test tape has come to light, though it seems that the GC/Audiotex cassette (30-212, \$5.58 list) could be used that way. "Dr. Tape" also has a test cassette, though it is not clear from the catalog description whether it will check track alignment (type X4-TC, \$2.98 suggested list).

A cassette test tape for setting standard level (0-VU on playback) and

checking frequency response and equalization is the AT-200 by Nortronic (6140 Wayzata Blvd., Minneapolis, MN 55416). There is also a 6.3-kHz tone for azimuth alignment. An unusually large number of tones is provided, from 31.5 Hz to 10 kHz—twelve in all.

Take good care of a test tape. It is best not to run it on fast-wind or rewind any more than necessary. Store it unrewound, and rewind just before using. Keep it away from dirt, excessive humidity and strong magnetic fields.

Clean and demagnetize heads before using the tape. You'd want to care especially well for the Ampex test tapes, which cost as much as \$35.

Audio Devices' (Audiotape) alignment tape No. 200 has the unique feature of being recorded in such a way that it doesn't require rewinding, eliminating one cause of flutter created by slight stretching in the tape itself.

Test records

All test records include most of the test material mentioned so far for tapes, except of course head (azimuth) align-

ment. Many of them have test bands for measuring intermodulation and other kinds of distortion caused by mis-tracking. Most have bands for checking turntable rumble. Some include stylus-wear test grooves, and a few have musical selections to be used for checking tracking and the overall subjective "quality" or "sound" of a system. Let's look in some more detail at a few of the more interesting tests.

In my opinion, the most interesting and generally useful test record—and definitely the one to get if you get only one—is *Stereo Review's* SR-12 Stereo Test Record. A complete inventory of the contents of this disc would take almost a whole column of print, but it includes everything from frequency-response and tracking tests to anti-skating adjustment and guitar-tuning tones!

Warbles for testing

One especially noteworthy feature of the SR-12 is its use of warble-tones or bands of noise rather than single-frequency signals. Pure tones can often be misleading, as for example when a part of the system (such as the speaker or listening room) has a slight but distinct resonance at a particular test frequency. The resonant peak might not be large enough to intrude on the program material, but it would be misleadingly noticeable during the test.

The first band of this record divides the upper part of the audio spectrum into eight half-octave bands, each recorded as a warble tone that sweeps rapidly up and down through all the frequencies of the half octave. The instruction booklet that accompanies the record goes on to say, "Unlike steady tones, the relative loudness of warble tones can be accurately compared by ear."

Each half-octave warble is separated by a reference warble (wonderful phrase!) which is always in the same half-octave (920–1,280 Hz), making a by-ear judgment of loudness unusually simple and valid. Each of the eight half-octave groups of warbles and reference warbles is run through twice—once for the left channel and once for the right. Takes a while to learn what to listen for, but it's worth the trouble.

A second band on the record covers, in the same way, the range from 20 to 920 Hz.

The separation test also uses warble tones with a reference warble, in five bands from 400 to 12,800 Hz, allowing you to tell pretty precisely how much leakage there is and in what frequency range it is worst or best. The *test* warble in each band is recorded in the left channel; the *reference* warble, 15 dB lower, is recorded in the right channel. You listen *only* to the right speaker. If the test and reference warbles are

(continued on page 93)



TYPICAL TEST TAPE checks many aspects of tape deck performance. This tape is used for cartridge machines. Others are made for cassette and open-reel players.

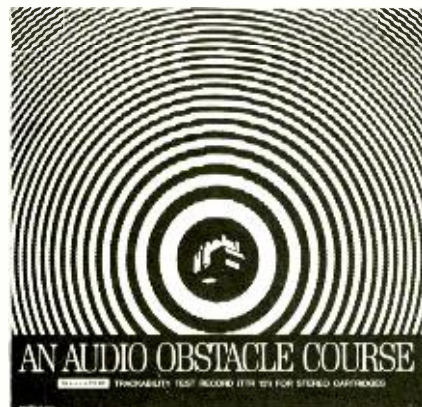

ONE OF MANY TEST RECORDS being made today. Periodic checks made using these test disks will keep your system at its best.

equipment report

RCA WC-528A curve tracer

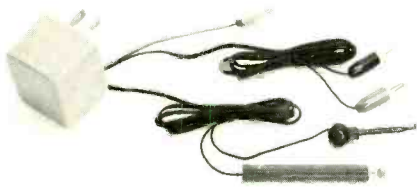

Circle 18 on reader service card

MOST TELEVISION MANUFACTURERS ARE committed to producing, with the exception of the kinescope, 100% solid-state receivers. With virtually all radios and high-fidelity components already in this category, it is absolutely essential that a serious service technician be able to rapidly determine the functional quality of a particular diode or transistor. These components are often soldered in place so it is important that in-circuit testing capability be provided. The time needed to remove and reinstall components added to the possibility of damaging the components

themselves or the printed boards tells us to avoid out-of-circuit testing whenever we can. The RCA WC-528A Quick-tracer fills the gap between the sophisticated curve tracer and the relatively crude ohmmeter diode testing method. It has positive in-circuit and out-of-circuit usefulness in a simple unit containing no active devices. I will show how this simple device used with an oscilloscope gives some of the accuracy of the curve tracer without its expense.

As anyone with solid-state servicing experience knows that transistors and diodes usually fail by a catastrophic mode—developing an open or short in one or more of its junctions. This explains the success of the ohmmeter method of measuring forward and reverse resistances of the junctions involved. However the variations in semiconductor leakage currents along with the variations in ohmmeters means in practice this method requires scale changing and reversing of leads. The ohmmeter method is not useable when the transistor or diode is connected in a circuit to other components, for it is im-

(continued on page 86)

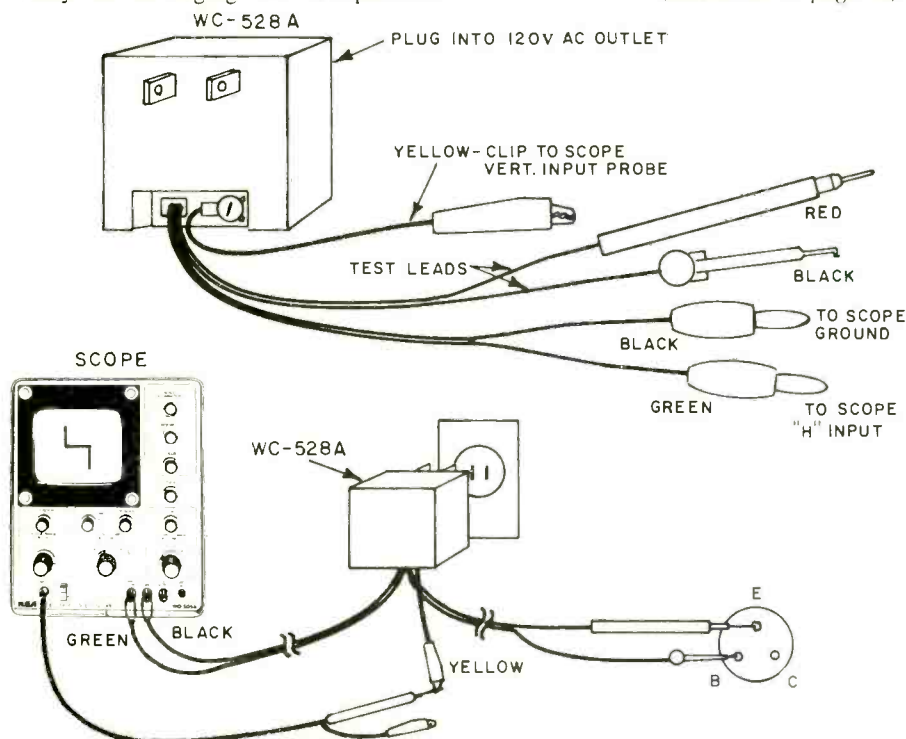

an electronic digital clock kit FROM \$39.50

FEATURING:

- extra large LED's
- detailed Step by Step Instructions
- Large Scale Integrated Circuits [LSI with BCD output and mounting socket]
- double-sided fiberglass PC boards
- 3 individual time-set buttons
- heavy [1/8"] brushed and anodized aluminum case



it's about time.

4 DIGIT [hours, minutes, and 1 sec. pulsed colon]

- DC4-E [electronics only] \$39.50
- DC4-K [complete kit] \$48.50
- DC4-M [assembled unit] \$89.50

6 DIGIT [hours, minutes, seconds]

- DC6-E [electronics only] \$49.50
- DC6-K [complete kit] \$58.50
- DC6-M [assembled unit] \$99.50

ORDER YOURS TODAY FROM:

mits

Micro Instrumentation & Telemetry Systems, Inc.
2016 San Mateo NE, Albuquerque, New Mexico 87110
505-266-2330

Changes come fast in electronics.



From
tube
to
LSI

Take a look at the race in circuit technology. In the 1960's the tubes at the left made way for the transistors at the right. Today, transistors are surpassed by the large scale integrated circuit (LSI) at the far right. This circuit, less than a quarter inch square, replaces over 6000 transistors!

There's big money to be made by the men who stay ahead of this technology race. Put yourself

ahead with NTS Home Training! You get the latest, most advanced equipment (at no extra cost). More solid-state units, and more advanced technology. Plenty of training with integrated circuits, too! As an NTS graduate, you enter a world of electronics you're familiar with. You have a thorough working knowledge of solid-state circuitry. You're ready to tackle bigger jobs at higher pay!

NTS COLOR AND B & W TV SERVICING

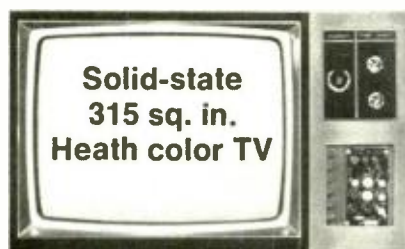

**Solid-state
315 sq. in.
Heath color TV**

Build and keep the largest, most advanced color TV made! Over-all solid-state design, ultra-rectangular screen, matrix picture tube, built-in self-servicing features, "Instant On," A.F.T., solid-state, 24-channel detent UHF/VHF power tuning, and much more! Also build and keep AM-SW Radio, Solid-State Radio, FET Volt-Ohmmeter, and Electronic Tube Tester. Learn trouble-shooting, hi-fi, stereo, multiplex systems, radio, color and B & W TV servicing.

Learn sophisticated solid-state circuitry as you build this B & W TV receiver. Lo-Silho "Superhet" Radio, FET Volt-Ohmmeter, Solid-State Radio, Electronic Tube Checker, and Signal Generator. TV

and all other equipment are yours to keep.

**Solid-state
B & W TV,
74 sq. in.
picture
(cabinet
included)**



NTS ELECTRONICS & COMPUTER TECHNOLOGY

Build and keep this exclusive NTS Compu-Trainer. It teaches you the

**Solid-state
Compu-Trainer
14 integrated
circuits replace
198 transistors!**



same principles used in million-dollar systems. Contains 14 inte-

grated circuits! All Solid-State! You perform all wiring and patchcording. No shortcuts. No pre-wired circuit boards. Your training is complete! Also receive an FET Volt-Ohmmeter and a 5" wide-band Solid-State Oscilloscope.

NTS ELECTRONICS COMMUNICATIONS

Gain the prestige and earning power of owning an F.C.C. First Class Radio-Telephone License. Two comprehensive NTS courses cover the big opportunity field of transmitting and receiving.

You build and keep 14 kits, including this amateur phone 6-meter VHF Transceiver, NTS's exclusive 6-transistor Solid-State Radio, and a fully transistorized Volt-Ohmmeter. Also, learn 2-way radio, Citizens Band microwaves, and radar.

**5-watt AM
transmitter/
receiver**



NTS Home Training puts you in the lead.

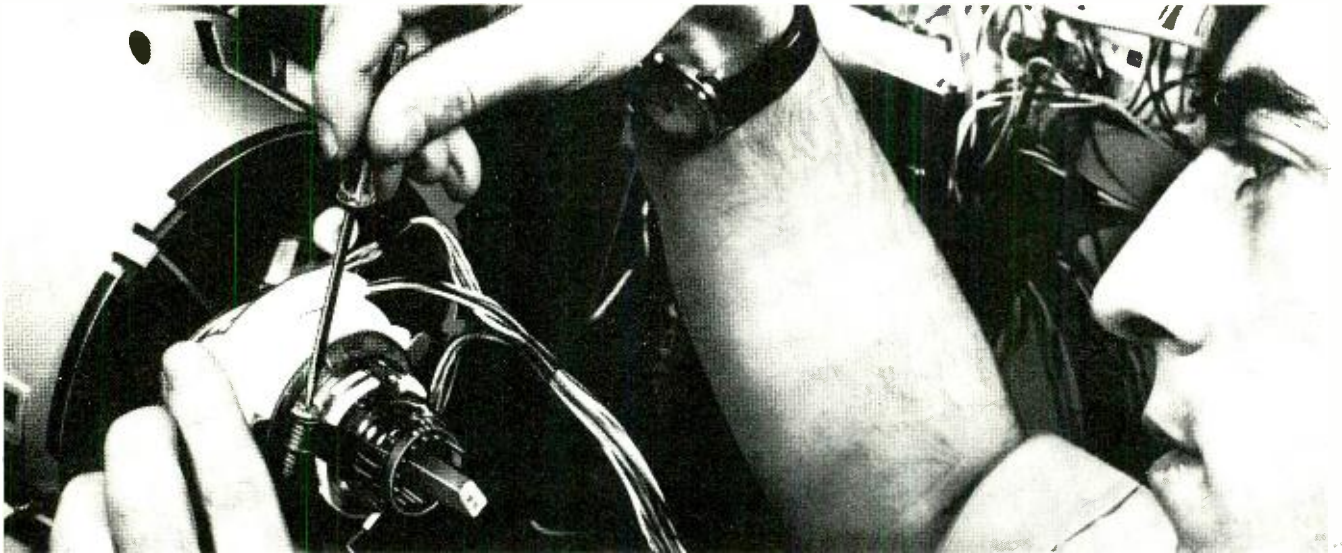

NTS INDUSTRIAL & AUTOMATION ELECTRONICS

Automation is the future of industry and you can play an important part! Learn industrial controls by training on the NTS Electro-Lab (a complete workshop). You also build and operate this 5" Solid-State oscilloscope. And you perform experiments that involve regulating motor speeds, temperature, pressure, liquid level, and much more. All equipment is yours to keep.

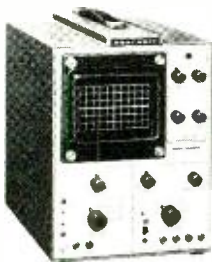

NTS AUDIO ELECTRONICS SERVICING

Learn basic sound theory—how it works in home radio, car tape

decks, stereo multiplex component systems, and more! Set up a spectacular music system. Learn about



Build and keep this famous Heath Stereo Receiver and Speakers.

sound distortion, amplification and control, loud-speaker baffles, problems of system installation, etc. Included is Volt-Ohmmeter, In-Circuit Transistor Tester, and Solid-State

Radio. Prepare yourself for great opportunities in the Home Entertainment Industry!

CLASSROOM TRAINING AT LOS ANGELES

You can take classroom training at Los Angeles in sunny Southern California. NTS occupies a city block with over a million dollars in technical facilities. Check box in coupon below.

NATIONAL TECHNICAL SCHOOLS

WORLD-WIDE TRAINING SINCE 1905

4000 S. Figueroa Street
Los Angeles, California 90037

APPROVED FOR VETERANS

Accredited Member: National Association of Trade and Technical Schools; National Home Study Council.

Big, Colorful NTS Guide to new opportunities in Electronics. Yours FREE!



NATIONAL TECHNICAL SCHOOLS
4000 S. Figueroa Street
Los Angeles, California 90037

Please rush me FREE Color NTS Electronics Guide & FREE lesson, plus information on course checked at right. No obligation. No salesman will call.

- MASTER COURSE IN COLOR TV SERVICING
- COLOR TV SERVICING (FOR ADVANCED TECHNICIANS)
- MASTER COURSE IN B&W TV & RADIO SERVICING
- MASTER COURSE IN ELECTRONIC COMMUNICATIONS
- PRACTICAL RADIO SERVICING
- FCC LICENSE COURSE
- MASTER COURSE IN ELECTRONICS TECHNOLOGY
- AUTOMATION & INDUSTRIAL ELECTRONICS
- COMPUTER ELECTRONICS
- BASIC ELECTRONICS
- AUDIO ELECTRONICS SERVICING

Dept. 206-072

NAME _____ AGE _____

ADDRESS _____

CITY _____

STATE _____ ZIP _____

- Check if interested in Veterans Training under new G.I. Bill.
- Check if interested ONLY in Classroom Training at Los Angeles

TeleMatic

PROFESSIONAL COLOR TV
SERVICE EQUIPMENT

ECONO JIG Color Test Jig



\$49.95 Net
less tube

- Complete with all components and cables.
- Durable metal cabinet.
- Professional equipment for rapid servicing.

ADAPT-ALLS Yoke Convergence Adaptors



- To service all sets with any test jig.
- FREE: Write for cross-reference listing thousands of sets.

TRANSVERTERS Service Solid State TV



- On any make test jig with simple plug-in Transverter.

MOLEX CUSTOM CABLE KIT Make all combinations of Molex Cables

CR-596 contains:

- Assortment of Molex Plugs and sockets.
- 18 wires, contacts attached.
- Extractor tool.

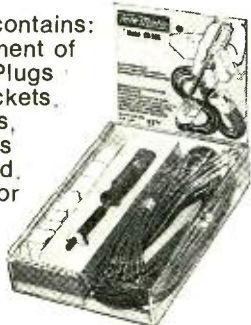

TELEMATIC DIV., UXL CORP.
2245 PITKIN AVE., BKLYN., N.Y. 11207

Circle 10 on reader service card

equipment report

International Crystal 6024

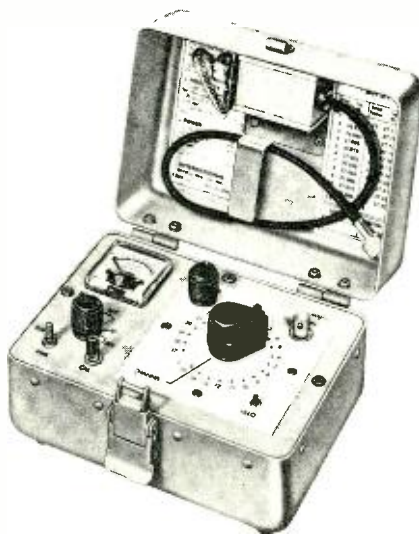

Circle 19 on reader service card

IF YOU WORK ON CB RADIOS, A FREQUENCY meter can be a great help. This compact little instrument gives you frequency readings well within the FCC standard of 0.0025%. The crystals are calibrated to better than 0.0002%, and as they say; "other errors will add up to a maximum of 0.0008%." Individual crystals are provided for each of the 23 CB channels. A spare position on the crystal-selector switch can be used for a Business-Band crystal, if needed.

Although it's not very large, the 6024 is housed in a very sturdy metal case, with a comfortable handle. All accessories stowaway inside the lid, and it weighs 4 pounds. The instrument is powered by two 6-volt NiCad batteries. The charge on these should last a long time since they thoughtfully provide a spring-return POWER switch (so that even I can't go off and leave it turned on)!

When they do need recharging, a special battery charger will bring them up from full discharge in about 15 hours. To find out how the batteries are doing, a 2-position BATTERY-TEST is included, on the METER switch. Each one is checked individually.

The CB transmitter's rf power output is read directly from the meter. It's plugged into a load box that contains a

50-ohm dummy load resistor, and the rf power output is read across it. Each of these instruments is individually calibrated at the factory, and a graph showing actual rf power vs meter reading is provided.

Although the 6024 is not intended to read modulation percentage, the presence or absence of modulation can be checked during the rf power output tests. Just whistle into the mike. If the reading goes up by one scale division, you're modulating. (Incidentally, if the reading goes down, and your rf power reading is below normal, you're over-modulating, and the transmitter should be checked to find out why.)

The crystals, with the built-in oscillator circuit, will also provide an accurate signal for aligning a CB receiver. The rf output is fed to the receiver antenna terminal, through the load box for perfect match, and all receiver tuned circuits can then be aligned for maximum output. Any kind of output indicator can be used; an S-meter, if it has one; or a vtvm on the receiver's avc line.

If the CB transmitter is off-frequency, the 6024 is set to the RF position, and the CAL adjustment set. Then the switch is returned to the RF position. The transmitter is keyed, and the RF level adjusted to bring the meter reading to a preset point, marked on the scale. The switch is then set to DEV(iation) and the transmitter keyed again. If the meter needle does not move, you're on-frequency. To be sure that everything is working, push the little HI-LO button, on the panel. If the meter reading goes up, the transmitter is above its assigned frequency; if it goes down, it's below frequency. For the closest possible adjustment, plug the earphones into the front-panel jack of the 6024, and you can hear the beat note between the transmitter oscillator and the crystal standard. Tune for zero beat, and there you are.

All in all, this is a deceptively simple looking but very rugged instrument that should be good for long service. Like all secondary frequency standards, it must have periodic recalibrations, at intervals of one year. Save the box it comes in for these occasional but necessary trips.

R-E

Long awaited, promised for years, the elusive home video tape recorder has finally arrived and can be yours if the price is right.



VTR's *ready for your home?*

by FRED PETRAS

yesterday, today, tomorrow

"ONE OF THE MAJOR PROBLEMS FACING THE BUDDING HOME video tape recorder market is the establishment of a set of standards as a foundation from which to develop compatible products." This statement—which neatly sums up the biggest current headache of the video tape recorder industry—was made back in April, 1965, by Jack Jones, then president of Wesgrove Electrics, Ltd., Worcester, England.

Wesgrove was an offshoot of Telcan, the company that any objective historian must say is the company that started the concept of "A video recording system in each home now equipped with a TV set." Telcan, back in mid-1963, announced a video tape recorder kit that was to sell for \$160. The set was a "brute force" longitudinal-scan model that drove quarter-inch tape past fixed video and audio heads at 150 ips.

While Wesgrove, *nee* Telcan, was a flop in the marketplace, it spurred many a company to develop VTR's. Many of these products—and some of their producers—also flopped. And the industry's history continues to repeat itself . . .

- At the moment the industry is still dreaming the dream of a huge "home" video tape equipment market, several years after it dropped the H for home from the HVTR designation of 1965/66/67. The reality is that it will not be a home market until the \$500 price barrier has been broken for a system that will record *in color* from a color TV and *play back in color*. For the moment no manufacturer can produce equipment anywhere near that price that will deliver a picture good enough for the average viewer to accept.

- The industry is still dreaming of a color VTR camera priced to match, and function with, the ideal under-\$500 VTR system. The reality is a price tag of \$4,900 for the lowest priced color camera in the market today. It's made by Magnavox. Mag-

navox is also working on a two-piece portable color camera for possible marketing later this year at "under \$2,000."

- The VTR industry has been dreaming a dream of software (tape) priced at around \$5 for an hour's record/play time to feed the vast markets-in-the-making. The reality is that the best current price is more like \$16. It has been dreaming of pre-recorded tapes containing full-length feature movies at a price of \$7.50 to \$10. The real price of such tapes is more like \$30 and up. The closest anyone has come to the dream has been a \$3 to \$6 rental charge for a *single viewing* of a feature movie in videotape form.

- The industry keeps dreaming of new and bigger figures for the current *real* VTR market—industry and education. Manufacturers dream dreams of new marketing approaches to gather bigger and bigger shares of market, implementing those dreams with new equipment designed to be *totally different* from anything else in the marketplace. The reality is that many a prospect for a VTR has been driven to choose other than VTR equipment for his needs, in the process dealing videotape a blow by aiding its heftiest competition—film.

What this all boils down to for the prospect who is determined to own a video tape system is that his wallet should be well stuffed before he takes off to buy. And, since there is no standard—and there may never be *one*—he must also have a lot of hope . . . hope that the system he eventually chooses as best for his particular needs is actually the best.

Video systems in the works

Confounding the prospect who has finally made up his mind that he is going to buy a video recorder of some sort, is the irritating awareness that no matter what he buys he will wish that he'd waited a bit longer, to compare upcoming goodies with those now in the marketplace. Under ordinary

circumstances we'd advise a prospect to wait the stated period before a system he was thinking about was scheduled to appear in a local electronics emporium. But . . . after following the industry for the past nine years we'd say "Forget it!" We've seen all sorts of timetables decimated—shot with delay after delay, change after change in concepts, pricing, etc. In the wrapup of upcoming systems below, we'd advise that you regard the availability times as tentatively tentative . . . subject to many possible vagaries.

Perhaps the most widely touted of all future systems is RCA's holographic SelectaVision. Its introduction has been moved ever farther into the future. Using three-dimensional photographic recordings made via, and viewed via laser beam, on a vinyl film medium, this playback-only system has oft been promised for a certain date, but that date has now been pushed far into the future. Some industry pundits claim that future is beyond our current lifetimes.

Meantime, RCA is working on a 3/4-inch magnetic tape color videocassette system called "MagTape" which is more likely to see the light of our days—perhaps by the end of 1973—if the company actually decides to market it. RCA claims that its record/play system will cost "significantly less" than other 3/4-inch videocassette tape systems in the works, but declined to say how much less. The compact system—said to be about the size of an 8-track home cartridge player—is not compatible with the Sony U-Matic color videocassette system.

Another widely touted format is the Philips (Norelco) VCR (for Video Cassette Recorder). Developed in the Netherlands about two years ago, the set—using half-inch chromium dioxide tape, or its equivalent, in a two-reel cartridge—was scheduled to be marketed here this summer at about \$1,000; the current price for it in the European market. But, said a source at Philips Broadcast Equipment Corp., "The VCR's future relative to the United States has not been decided." He said that the concept had been demonstrated to some sources in the U.S. and that some additional engineering was under way. For the moment, Philips is in the American marketplace with a portable half-inch reel model marketed by Videorecord Corp. of Westport, Conn. (see table of available VTR's for details). However, the VCR concept may hit the U.S. market by year's end if plans of Grundig, major European tape equipment maker, materialize. The company is reported to be planning a VCR-type unit as part of an international line. Other companies including AEG-Telefunken, Blaupunkt and Loewe-Opta are reportedly developing Philips-type VCR's. Some Japanese firms are also looking into the feasibility of the concept for marketing outside of the U.S.

The third most-talked-about video concept—a play-only proposition—is the Teldec Video Disc. Utilizing thin plastic discs that play at 1,500 rpm, the system was developed over a five-year period by British Decca, Teldec, and AEG-Telefunken of West Germany. The system uses 7- and 12-inch recorded discs that contain 5 or 12 minutes of moving picture/sound information. These are reproduced through a color or black and white TV set to which the Teldec video disc player is attached (via the set's antenna terminals). Originally scheduled for marketing in the U.S. around mid '72 in black and white, the system's introduction date (for a color version) has been pushed well into 1973. The original tentative prices of \$150 for a manual player and \$250 to \$300 for an automatic changer model, have been upped substantially. The playing time costs for Teldec discs are expected to be lower than for any other competing video playback system, the company claims. Recent reports indicate that Teldec may be able to offer 15 minutes of playing time per disc.

Another video disc system—using a laser for recording—is under development by MCA, Inc., on the West Coast. It is scheduled to be demonstrated sometime this year. The system's program capacity is up to a half hour per disc. The "guesstimate" price range for a player is \$150 to \$200. There's still another video disc system reportedly in the works—at RCA. It's labelled "Top Secret," hence, no details.

In various stages of development in the U.S. are two film systems that function through TV sets. Chief contender in a race that has not yet actually begun, is Kodak. A few months ago it demonstrated a "feasibility" model of a system using Super-8 movie film encased in a cartridge. The player—about the size of a stereo tape deck—hooks into the antenna terminals of an existing color TV set. The film moves past a flying

NORELCO LDL-1000
reel-to-reel video
recorder/player uses
1/2-inch tape travelling
at 7.9 inches/second.



**VIDEOCASSETTE
PLAYER, Wollensak
model VR-205 with
colorbar display on
monitor receiver.**



**INTERNATIONAL
VIDEO's model 700
recorder/player em-
ploys 1-inch tape
moving at 6.9 ips.**

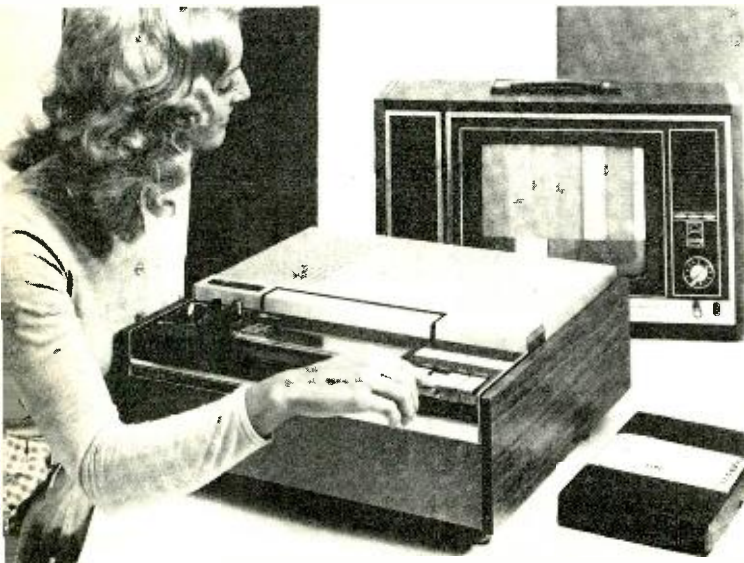

spot scanner that translates the film images into TV signals. The sound is magnetic. A singular advantage of the format is that it permits the use of existing Super-8 reel films—with or without sound—to be played as before, on movie projectors, or by merely dropping them into a cartridge for use through a TV set. Kodak has not committed itself to making or marketing the system, so we'd suggest you *not* wait . . .

Another big film company, Polaroid, has filed a patent application on a new videoplayer system, details of which we had not come by at presstime. All we know is that it uses Super-8 film.

A third film system—this one using 4x 5-inch photo cards—is being developed by Digital Recording Corp. and Batelle Development. Digitally encoded electrical signals are optically recorded at extremely high information densities on the cards, which provide up to 30 minutes of record/play time.

In other parts of the world NordMende (Germany), Eumig (Austria), Vidicord (England) and Fuji and Japan Electron Optics Lab. (Japan) are working on film video systems. The Fuji system, called CVR for Cine Video Recording, may be entering the U.S. market by year's end. The Eumig and Vidicord formats were to have been introduced in 1971. The NordMende was originally scheduled for this year. Stand by!

AKAI VTS-100-DX (left) uses 1/4-inch tape and includes a camera and portable 3-inch monitor.



THE VPR5200 (below) is one of Ampex's four VTR's using the 1-inch video tape.

CARTRIVISION system records off air and plays back through TV receiver. Emerson version is at right.



Additionally, a couple of other companies, namely Retention Communications Systems and N.V. Philips, are working on film approaches that do not require a TV set for playback.

Also in the works at Sony Corp., Japan, is a color video projection system that shows videotape-recorded pictures on a 50-inch screen. Developed primarily for VTR use, the device can also show large telecast pictures received through an ordinary color TV set with the aid of a special tuner. Tentative price for the system—when available in the U.S.—is about \$2,500.

Although the longitudinal-scan VTR of Westgrove/Telcan fell by the wayside, the concept did not. While other companies such as Fairchild Camera (Winston Research Div.), Ampex, Par, Akai, Shiba Electric, American Engineering, and Mastercraft, among others, have worked on it—and dropped it—the concept is getting another look-over, namely from Marvin Camras of the Illinois Institute of Technology Research Institute. Camras, holder of many basic patents in the tape recording field, is reported to have come up with a quarter-inch color videocassette recorder that may well jolt the industry with a price tag of around \$300. The system, according to reports, is *not* likely to appear at Ye Local Electronics Emporium this year.

The foregoing is not a complete list. There are a number of other companies working long hours in R & D. By the time this appears in print there may be other announcements of one or more new systems.

Underlying the above are experiments and developments in raw tape technology. One that is being watched with both hope and trepidation is Cobaloy, a new magnetic tape particle from Graham Magnetics, Inc., of Texas. The tape particle promises over four times the recording capability of existing audio and video recording tapes. It might mean tape speeds of one fourth those used now, or four times as much recording potential for a given tape length. It also holds potential for smaller, more portable VTR equipment. The impact on the industry could be overwhelming . . . However, *don't* hold your breath waiting for that impact. Graham—many months after announcing the new particle—has yet to produce a saleable tape using that particle.



today—what you can buy now

A look at the availabilities in video tape equipment shows that there are roughly 75 models in the under-\$4,000 price range. For space reasons, we'll limit our chart to some 50 representative models in major, nationally-distributed brand names. Units or systems listed are production realities—not proposed equipment. We've been assured by manufacturers and importers that the equipment will actually be in the marketplace by the time this appears in print. As with any other electronic product, local availabilities will depend on local marketing practices and conditions. Not every store in your neighborhood is going to be handling VTR equipment at this stage of the game.

The detailed chart shows that some progress has been made in standardization in the past few years, with far more machines compatible with each other than, say, in 1968. This could be a key consideration in your buying plans. Several Japanese firms—Shibaden, Sony, Matsushita (Panasonic) and JVC—plus U.S. Concord and Ampex, have adopted the Electronic Industry of Japan (EIAJ) "Type One" standard of half-inch magnetic tape for black-and-white VTR's, and are working within the framework of an EIAJ-recommended standard of half-inch tape for color VTR equipment. Tapes of each standard are compatible—that is, they can be interchanged and played on other machines within each or both standards. Of course, a Type One color tape played on a Type One monochrome machine will reproduce in black-and-white; and conversely, a black-and-white tape played on a Type One color machine will reproduce only in black-and-white.

Sony Corp. of Japan has JVC (Japan and U.S.) and Wol-

lensak of the U.S. on its side in promoting the ¾-inch magnetic tape videocassette called "U-Matic." Upcoming, perhaps later this year, will also be such machines from Matsushita (Panasonic) and Concord. Also amenable to the U-Matic approach are Shiba, Teac, Akai and Nippon Electric Co., all of Japan.

The situation regarding CBS Inc.'s Electronic Video Recording (EVR) format has been pretty much resolved. CBS recently phased out of active EVR production and marketing, but retains its patent royalty rights to the concept and may also furnish programming to be shaped into the EVR format. Motorola is producing EVR equipment for the U.S. market and will later make it also for the European market. Possibly coming in with such equipment later this year are four Japanese firms—Hitachi, Mitsubishi, Toshiba and Matsushita (Panasonic). Manufacturing EVR in the United Kingdom is Rank Bush Murphy. Other companies originally scheduled to make EVR's for the European market are Thompson CSF, France; Zanussi, Italy; Robert Bosch, Germany/Austria; and Luxor for the Scandinavian countries.

Avco's Cartrivision is entering the consumer market under the Sears Roebuck logo. Additionally, several other companies will be marketing it under their own brand names, in a variety of cabinetry and equipment combinations and prices. Among those scheduled to sell Cartrivision are Admiral, DuMont, Emerson, Packard Bell and Montgomery Ward. Magnavox, is market-researching the format via its dealers but has not committed itself to actually selling Cartrivision.

So, summing up, if compatibility is important to you, you have four different major systems from which to choose. Plus limited compatibility within the framework of a few companies' VTR lines, namely Ampex and IVC, in one-inch tape formats, and Akai in the quarter-inch.

CHARACTERISTICS OF AVAILABLE

Brand	Model	Type	Medium	Tape/Film Reel/Cart		Speed (ips)	Maximum Time	Video Heads	Lines of Horizontal Resolution		Audio Bandwidth (Hertz)	Power Source	Function Rec/Play	Approx Price	Notes
				Width (Inches)	Size (Inches)				Color	B/W					
Akai	VT-700	Reel	Tape	¼	10½	11¼	2 hrs	2	200	100/10,000	ac	Rec/Play	\$929.95	Price of VT-100S and VTS-110dx includes camera built-in monitor and AC power supply/battery charger	
	VT-100S	Reel	Tape	¼	5	11¼	20 min	2	200	100/10,000	ac and 12V dc	Rec/Play	\$1,295		
	VTS-110dx	Reel	Tape	¼	5	11¼	20 min	2	200	100/10,000	ac and 12V dc	Rec/Play	\$1,595		
Ampex	VR-420	Reel	Tape	½	7	7½	60 min	2	230	300	70/10,000	ac	Rec/Play	\$1,200	
	VPR-4500C	Reel	Tape	1	9½	9.6	60 min	1	350		90/9,000	ac	Play	\$2,150	
	VPR-4500	Reel	Tape	1	9½	9.6	60 min	1		350	90/9,000	ac	Play	\$1,650	
	VPR-5100	Reel	Tape	1	9½	9.6	60 min	1		300	90/9,000	ac	Rec/Play	\$1,800	
	VPR-5200	Reel	Tape	1	9½	9.6	60 min	1		300	90/9,000	ac	Rec/Play	\$2,600	
AVCO	Cartrivision	Cart.	Tape	½	1½ x 6½ x 7½	3.8	114 min	3	250			ac	Rec/Play	\$1,350	Price includes 25-inch color set. See text for list of brand names.
Concord	VTR-800	Reel	Tape	½	7	7½	60 min	2	240	300	80/10,000	ac	Rec/Play	\$800	Price includes camera.
	VTR-1100	Reel	Tape	½	7	7½	60 min	2		300	80/10,000	ac	Rec/Play	\$1,295	
	VTR-460T	Reel	Tape	½	5	7½	30 min	2	300	80/10,000	ac or 12V dc	Rec/Play	\$1,350		
	VTP-360	Reel	Tape	½	7	7½	60 min	2	260	300	80/10,000	ac	Play	\$875	
	VTP-310	Reel	Tape	½	7	7½	60 min	2	300	80/10,000	ac	Play	\$575		
VTR-648	Reel	Tape	½	7	5/32 to 12	Up to 48 hrs	2	260	80/10,000	ac	Rec/Play	\$1,750			
International Video Corp. (IVC)	700-PB	Reel	Tape	1	8	6.91	60 min	1	350	75/10,000	ac	Play	\$1,800		
	700-CPB	Reel	Tape	1	8	6.91	60 min	1		75/10,000	ac	Play	\$2,300		
	700	Reel	Tape	1	8	6.91	60 min	1	350	75/10,000	ac	Rec/Play	\$2,250		
	700-C	Reel	Tape	1	8	6.91	60 min	1	350	75/10,000	ac	Rec/Play	\$2,750		
	800A-SM	Reel	Tape	1	8	6.91	60 min	1	400	75/10,000	ac	Rec/Play	\$3,500		
	800A-SM-C	Reel	Tape	1	8	6.91	60 min	1	400	75/10,000	ac	Rec/Play	\$4,000		
JVC-America	CR-6100	Cass.	Tape	¾	8¾ x 5½ x 1¼	3¾	60 min	2	240		50/12,000	ac	Rec/Play	\$1,850	
	CP-5000	Cass.	Tape	¾	8¾ x 5½ x 1¼	3¾	60 min	2	240		50/12,000	ac	Play	\$1,150	
	KV-350	Reel	Tape	½	7	7½	60 min	2	300	80/10,000	ac	Rec/Play	\$795		
	PV-4500	Reel	Tape	½	5	7½	30 min	2	300	100/10,000	ac or 12V dc	Rec/Play	\$1,780		
	FV-3500	Reel	Tape	½	7	7½	60 min	2	230		80/10,000	ac	Rec/Play	\$1,250	

Since the industry is in a perpetual state of transition, we'd advise you to check out the compatibility factor before you buy to know exactly what a given machine is compatible with. For example a given company's half-inch machine operating at 7½ ips is not necessarily compatible with another company's 7½ ips/half-inch machine, since one uses the EIAJ standard, the other doesn't. Another point: You may find that a certain brand machine in other than the four major standards is not limited in compatibility only to others within the same brand name. For example, IVC makes certain basic VTR's that are sold by other companies under their brand names. Tapes made on any one of these machines are compatible with the others, regardless of the brand name.

In examining the chart you'll see a dozen different speed designations, ranging from 5/32 ips on up to 12 ips in special-application equipment, and from 3¼ to 9.6 ips in most general-use models. These speeds should not be confused with those of audio equipment. In an audio recorder—which uses the longitudinal drive system—the tape moves at a speed of say, 7½ ips, parallel across the face of a *stationary* erase, record and play heads. *Actual* tape-to-head contact is made at the designated 7½ ips. However, in a video recorder things are a bit different. . .

Except for EVR, all of the models in our chart use the helical-scan principle. In most such equipment one or two record/playback heads are mounted on a rotating scanner and record a series of diagonal tracks across the tape. While the tape may actually be moving around the scanning drum at speeds in the 3¼ to 9.6 ips range, the *relative* tape-to-head contact may be at speeds ranging from 280 to 1,000 ips, depending on the tape width (quarter-inch to one-inch). This moving tape-to-head contact is called the "writing speed". Thus, for example, a machine running at 9.6 ips and using

one-inch tape would be "writing" at a speed of 1,000 ips.

Some manufacturers/importers gave us approximate "cost per hour" figures for blank video tapes. Others declined, saying that retail competition would determine the actual selling price of raw tapes. Further, there is the angle that shorter tape lengths cost more per reel than do the longer ones. For instance, a U-Matic cassette of 10 minutes record/play time would cost \$17; a similar cassette offering 20 minutes of use time would cost \$20; a half-hour cassette would go for \$25; whereas a full hour cassette would sell for \$35. Generally, you can figure blank tape costs for an hour's recording time in the half-inch EIAJ formats at about \$40. Avco figures half-inch tape costs for Cartrivision at about \$16 per hour, since the system operates at a slower speed. For the Akai quarter-inch format operating at 11¼ ips the tape cost is \$23.85. Ampex puts the cost of an hour's recording time in its one-inch format operating at 9.6 ips at around \$60.

As for the playback-only medium—EVR—program material costs are a highly involved matter, covering such points as artist royalties, shortrun versus mass duplication, and many other variables. However, one estimate puts the film-plus-duplication cost for 25 minutes of color programming at about \$18 per cartridge in lots of 2,000 or more, exclusive of royalties, etc., on the program content. A look at Motorola's catalogue of pre-recorded EVR cassettes on health care shows prices ranging from \$6 per minute for black-and-white programming, on up to \$14 per minute for color programming.

What about cameras, monitors, and other related equipment to go with the VTR's listed? There's plenty available, to suit any budget. Every company offers some exclusive features and has accessory equipment to enable you to develop a video system for your particular needs, be it minimum or maximum type. **R-E**

HOME VIDEO RECORDERS

Brand	Model	Type	Medium	Tape/Film Reel/Cart		Speed (ips)	Maximum Time	Video Heads	Lines of Horizontal Resolution		Audio Bandwidth (Hertz)	Power Source	Function Rec/Play	Approx Price	Notes
				Width (Inches)	Size (Inches)				Color	B/W					
Javelin	X-400	Reel	Tape	½	7	1 1/16 & 7½	7 hrs	4	300	80/10,000	ac	Rec/Play	\$2,150	Features time lapse, still frame stop, slow motion. See Text for brand names.	
Motorola	EVR	Cart.	Film	8.75 mm	7 diam x ½	6 (60 FPS)	25 min 50 min	C B/W	300	500		ac	Play	\$795	
Norelco	LDL-1000	Reel	Tape	½	6	7.9	38 min	2	200	120/10,000	ac	Rec/Play	\$895	Price includes 12-inch monitor.	
Panasonic	NV-3010	Reel	Tape	½	7	7½	60 min	2	300	80/10,000	ac	Play	\$575		
	NV-3020	Reel	Tape	½	7	7½	60 min	2	300	80/10,000	ac	Rec/Play	\$795		
	NV-3130	Reel	Tape	½	7	7½	60 min	2	240	300	80/10,000	ac	Rec/Play	\$1,500	
	NV-8020	Reel	Tape	½	7	5/32 to 12	48 hrs	2	260	80/10,000	ac	Rec/Play	\$1,750	Features 5 speeds, time lapse, still frame stop.	
	NV-3080	Reel	Tape	½	5	7½	30 min	2	300	80/10,000	12V dc	Rec/Play	\$1,250	Price includes camera.	
	NV-504	Reel	Tape	1	8½	8.57	67 min	2	240	450	80/8,000	ac	Rec/Play	\$3,950	
Sanyo	VTC-710	Cass.	Tape	½	5½ x 3½ x 13/16	4%	12 min		250			ac or 12V dc	Rec/Play	\$1,500	
	VTR-1100SH	Reel	Tape	½	7	1 1/16 & 7½	7 hrs	2	300	80/10,000	ac	Rec/Play	n.a.		
Shibaden	SV-510U	Reel	Tape	½	7	7½	60 min	2	300	70/10,000	ac	Rec/Play	\$695		
	SV-520	Reel	Tape	½	7	7½	60 min	2	240	300	70/10,000	ac	Rec/Play	\$1,295	
	SV-707U	Reel	Tape	½	5	7½	20 min	2	300	80/10,000	ac or 12V dc	Rec	\$1,395	Price includes FP707 Camera.	
	SV-800UC	Reel	Tape	½	7	7½	60 min	2	300	60/10,000	ac	Rec/Play	\$1,295	Price includes 9-inch monitor built into carry case with recorder.	
Sony	VP-1000	Cass.	Tape	¾	8¾ x 5½ x 1 ½	3%	60 min	2	240	300	50/12,000	ac	Play	\$995	Available as Wollensak Model VP-205
	VO-1600	Cass.	Tape	¾	8¾ x 5½ x 1 ½	3%	60 min	2	240	300	50/12,000	ac	Rec/Play	\$1,395	Available as Wollensak Model VR-210
	AV-3400	Reel	Tape	½	5	7½	30 min	2	300	100/10,000	ac or 12V dc	Rec/Play	\$1,495	Price includes AVC-3400 camera.	
	AV-3600	Reel	Tape	½	7	7½	60 min	2	300	80/10,000	ac	Rec/Play	\$695		
	AV-3650	Reel	Tape	½	7	7½	60 min	2	300	80/10,000	ac	Rec/Play	\$995		
Wollensak	VP-205														See notes under Sony
	VR-210														See notes under Sony



Hallicrafters SX122-A receiver

SINGLE SIDEBAND(SSB) TRANSMISSION has long been used in transatlantic telephone and in line telephone carrier service. It is now practically taking over much of our low-power point-to-point (especially mobile) commercial communications. Most of the amateur phone operators also use sideband, and CB sideband rigs are now available. And for good reason: sideband makes it possible to put a good signal into the receiver with about one quarter the power needed for ordinary AM. At the same time it reduces interference and receiver noise, and permits almost twice as many stations to operate in a given frequency band.

Yet single sideband is by no means as well understood as it should be. Most operators of SSB equipment just don't know how it works. Or even what it is! We hear people talk about AM, FM and SSB as if they were three different things. (Yet SSB really is AM—ordinary AM is just double sideband.) What is so mysterious about sideband?

The way we heard it

Possibly the hardest thing to understand about SSB is the language used to describe it. We "learned" in our beginners' texts that AM consists of a center *carrier* frequency with a lot of sidebands (or maybe only two, if a single tone was being transmitted) on each of it. The job of the carrier seemed to be just to drag the sidebands along, because we get all the information from them, not the carrier.

So far, it sounds simple enough, if true. But is it true? Would it surprise you to know we can get along without that carrier? And that if we suppress it and just transmit the sidebands, we can send the same information with a lot less power? Furthermore—since the two sidebands are identical—that we can suppress one of them, too, and get the same results at the receiver?

But if that center frequency is a carrier, how do we get the signal from

modern radio SINGLE-SIDE

Reduced interference and greater range
SSB. Here's a look at basic circuits

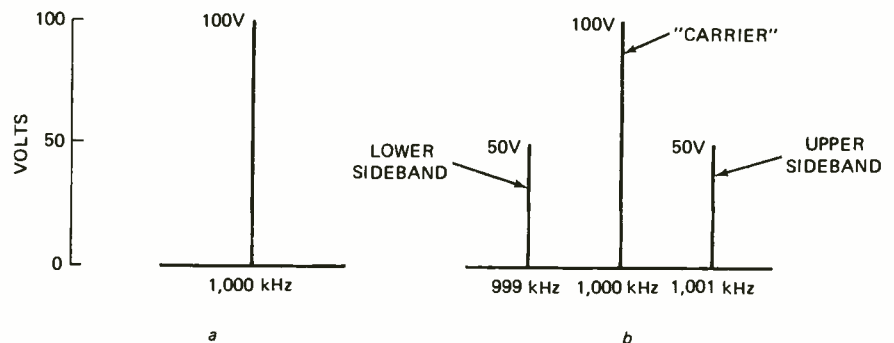

FIG. 1-a—RADIO SIGNAL at a frequency of 1,000 kHz. b—same signal modulated by a 1-kHz signal, showing two "sidebands."

transmitter to receiver without it? And more puzzling still, our SSB texts tell us we have to *re-insert* the carrier at the receiver to get the information out of an SSB signal. Let's just change that term "carrier" to "reference frequency" and see what really happens:

How it works

Fig. 1-a shows a continuous radio signal on exactly 1 MHz (1,000 kHz). This signal can carry information if we start and stop it in a series of dots and dashes (continuous wave telegraphy). But to carry such complex information as voice, it has to be *modulated* (varied or changed in strength, if we are talking about amplitude modulation).

Suppose we vary this signal with a 1,000-Hz (1 kHz) note, with the help of a microphone and an audio amplifier. Instead of using an output transformer designed for a speaker, this amplifier feeds into the primary of a *modulation transformer*. The secondary of this transformer is in the power supply circuit of the transmitter output (Fig. 2). Thus the transmitter output is boosted and reduced 1,000 times a second, and the strength of the transmitted rf signal varies at the same rate.

But—as you also learned from your elementary studies—another interesting thing happens. Any time you modulate a signal of one frequency with one of a different frequency, you create still other frequencies. The strongest—and sometimes the only—ones are at the sum and difference of the original two. Thus the output of the transmitter now contains a *difference signal* at 999 kHz and a *sum signal* at 1,001 kHz (Fig. 1-b) as well as the original 1-MHz signal. A 2-kHz note would produce frequencies at 2,000 Hz above and below the center frequency, and an orchestra a fantastic combination of frequencies.

Now these frequencies—call them sidebands or not—are true radio signals, as capable of getting to their destination as is the center (miscalled carrier) frequency. And that is just what happens in SSB.

But note from Fig. 1-b that the "carrier" which transmits no information has twice the voltage of the information-carrying sidebands. For mathematical convenience, we'll call it 100

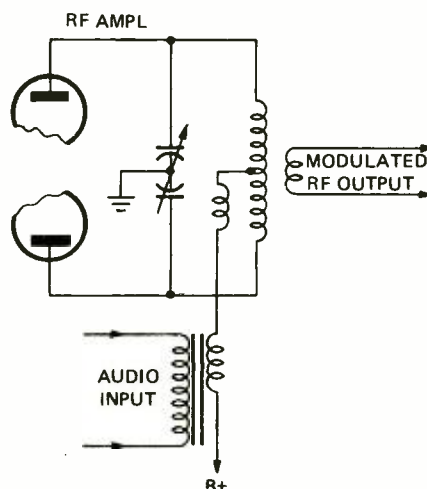

FIG. 2—MODULATING an rf amplifier.

techniques

BAND MADE EASY

with limited power are major assets of used in the receiver and transmitter

by FRED SHUNAMAN

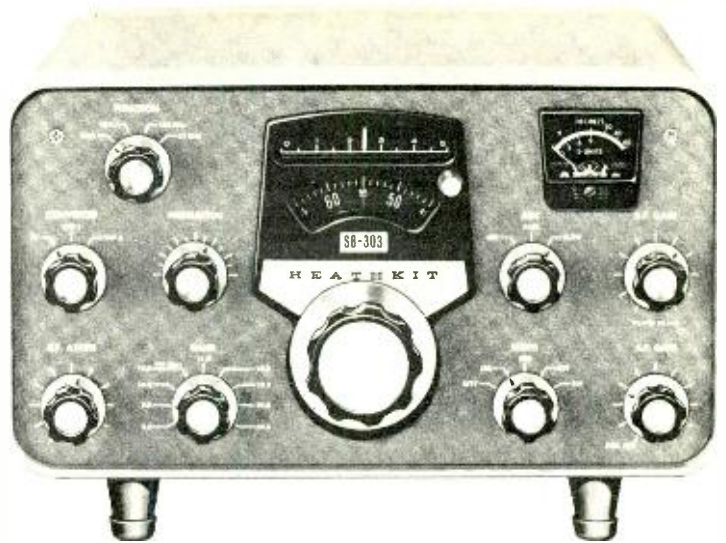

Heathkit SB-303 receiver

volts. Suppose we think of these signals working into a load, say 500 ohms. Then our 100-volt carrier would have a current of 1/5 (0.2) ampere and a power of 20 watts. The 50-volt sidebands, with a current of 0.1 A each, total 10 watts. Two-thirds of the power is in the "carrier," which carries nothing!

But how do we get rid of that car-

to 1,003 kHz in our sidebands.)

But we still have the two sidebands. How to dispose of the one we don't need? The simplest way is just to tune it out! That may sound like tuning out the instruments in an orchestra and hearing the violin alone, but it's not that bad. Remember that the signals are now on (slightly) different frequency bands,

adjustments and controls are needed to avoid distortion. But these details would add up to a story of their own. The fundamentals are really simple.

SSB reception

Now we get to the receiver. Here we run into another problem. SSB is AM all right, but how do we detect ordinary AM? The term is *demodulate*, and that is just what is done. This band of frequencies is beaten against (heterodyned with) the original carrier. The 1,001-kHz signal again becomes a 1-kHz audio signal, and so for the rest of the frequencies. But we have no carrier! (At last we know what it's good for—a reference frequency to help in demodulation.) And since the strength of the audio signal is proportional to the *product* of the carrier and modulating signals, we can see why transmitting a strong carrier was excusable—in fact, desirable.

But there is a simple way out. We *re-insert* the carrier frequency at the detector. Since that frequency is now the intermediate frequency of the receiver, all we need is a signal at the i.f. (The bfo of a communications receiver is commonly used to demodulate SSB signals.) The new "carrier" now beats with any signal that was 1-kHz away from the original carrier frequency to produce a 1,000-Hz note, and with phone signals to reproduce the original speech.

The output of a beat frequency oscillator (bfo is not usually strong enough for best detection (remember the audio output is a product of the "re-inserted carrier" and the modulating signal) so special detectors (Fig. 4) are normally used. Not surprisingly, these are called "product detectors."

A transmitter may use either sideband and most receivers have a switch to receive the one being transmitted. Some transmitters operate with *two independent sidebands*, are able to *send two messages simultaneously*. With this technique, a central station can prac-

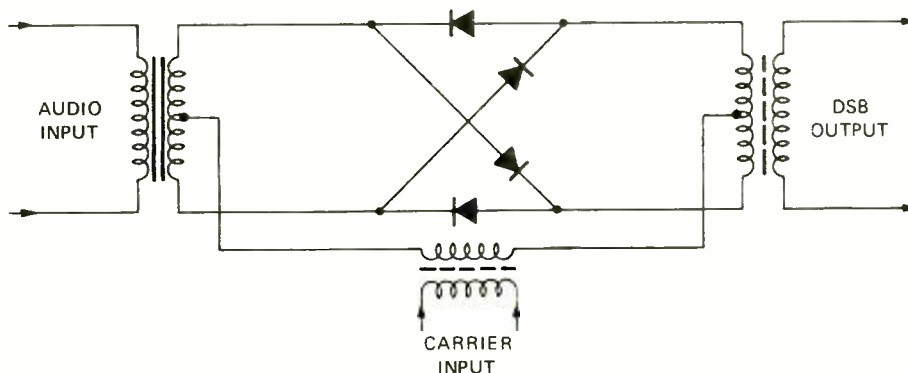

FIG. 3—A BALANCED MODULATOR. The carrier voltage flows both ways through the coils and is the same at either end of the output coil until the diode biases are upset by an audio-frequency modulating signal.

rier, that uses up so much power for so little value? (It does have *some* use, but we'll come to that later.) *Balancing* is the answer! A *balanced modulator* like that of Fig. 3 can be so adjusted that when the 1-MHz signal is applied to the carrier input, there will be no signal in the output coil. But a signal in the audio input heterodynes with the carrier to produce 999 and 1,001-kHz signals that do get through. We have our sidebands without the carrier!

And, of course, if we modulate with speech, we have a flock of sidebands, ranging from the lowest to the highest our equipment will pass. (Most commercial and much amateur equipment limits the audio signal to a band ranging from 200 or 300 Hz to 3,000 Hz, to economize the bandwidth. Thus we might expect to find signals ranging from 997 to 999.8 kHz, and from 1,000.2

with a little gap between them. Special circuits can suppress one of the bands without doing too much harm to the other.

Another method is more ingenious. Called the "phasing" technique, it splits the signal into two parts and recombines them so that one set of sidebands (either the upper or lower) reinforce each other, while the other pair cancel. Both methods are practical and both are used.

Not quite as easy as that!

Is SSB really that simple? Not quite. We have passed lightly over filtering out the unwanted sideband, but in a real transmitter it is an important problem. The rf signal is modulated at a low frequency and a low power level. Extra stages are needed to bring it up to output frequency and power. Special

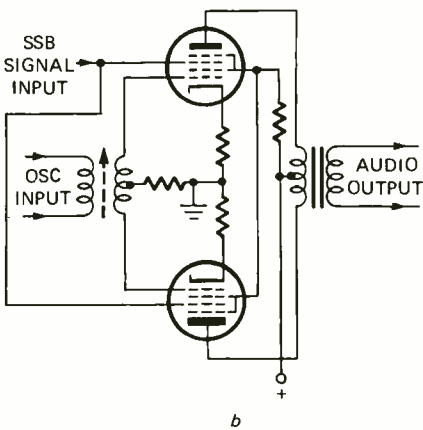
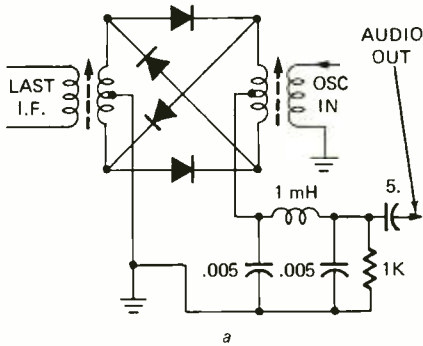

FIG. 4—TUBE AND SOLID-STATE SSB detectors. Both are balanced to reduce noise and interference; will not pass ordinary amplitude-modulated signals. (a was first described by Hayward and Bingham; b by Oswald G. Villard.)

tically double its message-handling capacity, by putting half its mobile stations on upper sideband and half on lower sideband and using the same transmitter to communicate with both.

Advantages of SSB

Why is SSB taking over in so many applications? Look at Fig. 1-b—note that two thirds of the power is in the carrier and only one third in the sidebands. By sending only one sideband, we can use a 5-watt instead of a 20-watt transmitter, with a great saving in size, weight and cost.

Other factors raise efficiency and make the saving even greater. For instance, the bandwidth is only half as wide, reducing both outside interference and receiver noise, and permitting more stations to operate in a given band.

At communications frequencies, selective fading is a problem. Very narrow bands—sometimes almost a single frequency—may fade. Fading of one sideband in double-sideband transmission distorts the signals. But if the carrier fades, distortion is worse and the intelligibility may drop to zero. With only one sideband—and the carrier carefully inserted at the receiver—selective distortion is avoided.

With all these bonuses, it is not surprising that SSB is making progress—even to the point that one day we may see it even on the broadcast band! R-E

Frequency—time conversion

Engineers, technicians and hobbyists regularly find it necessary to convert frequency into time or vice versa when working instruments where time or frequency conversion is of importance. This graph and the table cover the bulk of the useful ranges.

Values between those on the table can be interpolated by looking back to the head of the table and inserting the decimal point accordingly. Thus 0.1 μ sec is the period of a frequency of 10 MHz, and 0.2 μ sec is equivalent to 5 MHz. So if .00100 MHz appears opposite to 1,000 μ sec (1 millisecond), obviously 2,000 μ sec would be the period of one cycle of a frequency half as great, or .0005 MHz.—Henry Linton, K2OHT

TIME-FREQUENCY CONVERSION

μ sec	msec	Seconds	Frequency MH	Frequency KHz	Frequency Hz
.1	.0001	.0000001	10.000	10,000	10,000,000
.3	.0003	.0000003	3.333	3,333	3,333,333
.5	.0005	.0000005	2.000	2,000	2,000,000
.7	.0007	.0000007	1.429	1,429	1,428,571
.9	.0009	.0000009	1.111	1,111	1,111,111
1.0	.001	.000001	1.000	1,000	1,000,000
5.0	.005	.000005	.200	200.	200,000
10.0	.01	.00001	.100	100.	100,000
50.0	.05	.00005	.020	20.0	20,000
100.0	.1	.0001	.0100	10.0	10,000
500.0	.5	.0005	.00200	2.00	2,000
1000.	1.	.001	.00100	1.00	1,000
5000.	5.	.005	.000200	.500	200
10,000	10.	.01	.000100	.100	100
50,000	50.	.05	.000020	.020	20.0
100,000	100.	.1	.000010	.010	10.0
1,000,000	1000.	1.	.0000010	.001	1.00
10,000,000	10,000.	10.	.00000010	.00010	.10

LEFT SIDE OF BOX IS ASSOCIATED WITH BOTTOM SCALES

THIS GRAPH COVERS THE FOLLOWING RANGE: .1 MICROSECONDS [10 MEGACYCLES] 10 SECONDS [.1 CYCLE]

RIGHT SIDE OF BOX IS ASSOCIATED WITH TOP SCALES

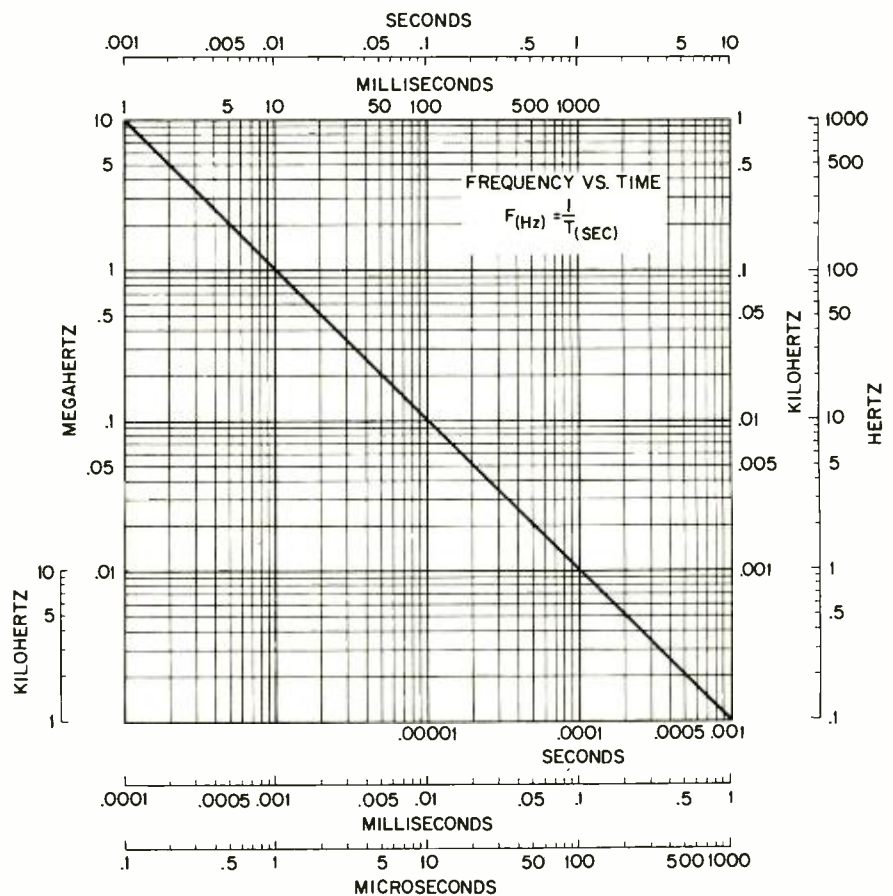







Kwik-Fix™ picture and waveform charts

Forest H. Belt & Associates®

SCREEN SYMPTOMS AS GUIDES

WHERE TO CHECK FIRST

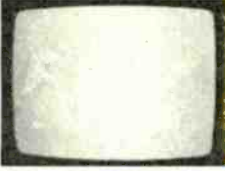
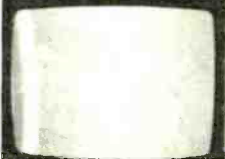
SYMPTOM PIC	DESCRIPTION	VOLTAGE	WAVEFORM	PART
	Picture washed out; smears; may be bars in picture	not much help	WF3	R1, R6, R7, C3
	Picture dark or nearly blacked out; little video	X1 collector	WF3	R1, R3, R4, R8, R9, C3, L2, L3, DL
	Picture overcontrasty and sharp	X1 collector	WF4	R3, R9
	Raster totally blacked out	X1 emitter X1 collector	WF3	R4
	Double images— one in color, one in black-and-white	X1 collector	WF3	DL
	Raster blank; no video	not much help	WF4	C4
	Brightness high	not much help	not much help	C4
	Overbright; white bar on left side of screen	X1 collector	WF3 WF4	C4

NOTES:

Use this guide to help you find which key voltage or waveform to check first, or to guide you to the causes of symptoms that don't have suitable voltage or waveform clues.

Study the screen and the action of the CONTRAST control.

The most helpful clues to the fault are to be found at the key test points indicated opposite whatever symptoms you observe.

With a station tuned in, make whatever voltage and/or waveform measurements are indicated for the screen symptom you see.

Use the Voltage Guide or Waveform Guide to analyze the results of those measurements.

For a quick check, test or substitute the parts listed as most likely to cause the symptoms you see.

The Stage

This most-common second video amplifier in color receivers—and in many monochrome sets—incorporates the contrast control into the emitter circuit. Potentiometer R7 varies degeneration in the stage by altering the effectiveness of electrolytic capacitor C3 as an emitter bypass. The delay line (DL) introduces a phase shift that lets video—more often called Y signal—reach the demodulators or the color picture tube at the same time as the chroma information.

Amplification amounts to about 10 times, depending on the CONTRAST setting. In most respects, this video stage has the characteristics you'd ordinarily expect in a common-emitter npn transistor amplifier.

Signal Behavior

The composite video signal, which includes horizontal and vertical sync, comes to this stage from the first video amplifier through R1. L1 makes an input load.

Transistor X1 amplifies the video signal. The RC networks in the emitter circuit alter the video somewhat. C1-R2 and C2-R5 sharpen up the edges of video-signal waveforms. The result, on the picture-tube screen, is cleaner distinction where black meets white in the picture. You can see the sharpness in color scenes too; the video signal is the Y or brightness component of color pictures.

R4 is the main emitter resistor, being higher in value than R3. Through small-value R6, electrolytic capacitor C3 acts as a signal bypass for R4. Potentiometer R7, the CONTRAST control, counteracts the emitter-bypass effect of C3. With the slider of R7 at the top, fully clockwise, the negative foil of the electrolytic is directly grounded. Efficient bypassing avoids signal degeneration in the stage by R4. Move the slider

downward, and the resistance of R7 keeps C3 from bypassing R4 so well. Degeneration, caused by R4 unbypassed, reduces overall gain of the stage. Amplitude of the video output is altered, and you see less contrast in the picture on the screen.

Output load is R8. The signal proceeds through peaking coil L2 to the delay line, DL. There, the video waveform is slowed down by about 1 μ sec. (The wide-bandpass video stages handle signals faster than chroma stages, which are narrower-band. The delay line slows video signals down to reach the picture tube at the same time as their companion chroma signals.)

Besides serving as output load for the transistor, resistor R8 and L2 terminate the input end of the delay line in its characteristic impedance. At the output end of DL, choke L3 and resistor R9 do the same. Otherwise, a standing wave could develop in the delay line and cause ringing in the video—even though the correct time lag were applied.

Too, R9 doubles as output load for the delay line. Capacitor C4 couples the now-delayed video signal on to the next video or Y stage.

DC Distribution

Base voltage for X1 in this stage comes from a dc coupling connection to the previous video stage. The L1 path feeds some of the dc voltage to the color killer.

The emitter dc path to ground goes through R3 and R4. Emitter-collector current develops a significant voltage drop across the two resistors; that's the emitter bias voltage. Capacitor C1 blocks any dc through R2, and C2 prevents R5 from being part of the emitter dc circuit. C3 blocks the dc path from R6 and R7, and keeps R7 from altering dc operation of the stage.

DC VOLTAGES AS GUIDES						
Voltage change	to zero	very low	low	slightly low	slightly high	high
X1 base Normal 4.4V	R1 open *	X1 shorted	R4 low	R1 high C4 open		
X1 emitter Normal 3.7V	R1 open	X1 faulty	R4 low	R1 high C4 open	R4 high R4 open	R3 open X1 faulty
X1 collector Normal 10V		R4 low	R8 open R9 open C1 leaky, shorted C3 shorted L2 open L3 open DL open X1 faulty	C4 open C4 shorted	R1 high	R1 open R3 open R4 open, high R8 low R9 low X1 faulty
Test point A Normal 7.4V				R1 open R4 open, low R8 low R9 low C4 open L2 open L3 open DL open		R4 leaky R4 shorted
	* negative					

NOTES:

Use this guide and the Waveform Guide to help you pinpoint the faulty part.

With the CONTRAST control about three-fourths up, tune in a strong local station.

Measure each of the four key voltages with the vtvm or fetvm.

For each, move across to the column that describes whatever incorrectness you find in that voltage.

Read which parts might cause that alteration.

Finally, notice which parts are also named as possible causes of other voltage changes you find.

Test those parts individually for the defect described.

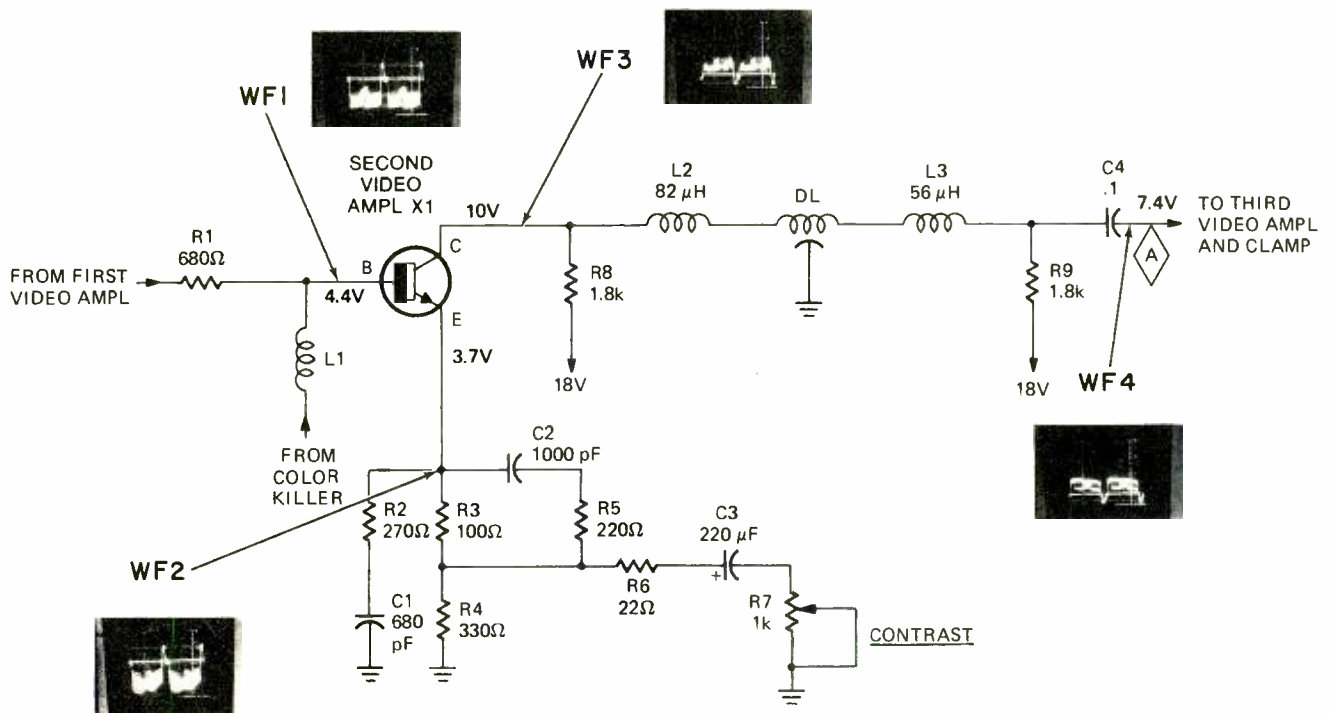

WAVEFORMS AS GUIDES

V p-p low	V p-p high	V p-p zero	Changed Shapes			
<p>WF1 Normal 1.5 V p-p</p> <p>Taken at base of the second video amplifier, this waveform has positive-going sync pulses. That means greater brightness points in the negative direction. Appearance of the video depends on what scene the station televises. The direct probe of the scope is okay for this waveform, and scope sweep set just below 8 kHz.</p>						
R4 low R8 open C1 shorted L2 open L3 open DL open			<p>0.7 V p-p R1 high</p>	<p>0.6 V p-p R1 open</p>	<p>0.8 V p-p R9 open</p>	
<p>WF2 Normal 1.5 V p-p</p> <p>Taken at the emitter, this waveform has the same polarity and amplitude as the input waveform. Because of the sharpening networks in the emitter circuit, leading and trailing edges may look sharper or have tiny overshoots. Such subtle characteristics are hard to recognize, or to use as trouble clues.</p>						
R4 low R8 open R9 open C1 shorted L2 open L3 open DL open		R1 open R3 open R4 open X1 shorted	<p>2 V p-p R1 high</p>	<p>1.5 V p-p R3 high</p>	<p>1 V p-p R3 low</p>	
			<p>0.6 V p-p R4 high</p>	<p>0.3 V p-p C3 shorted</p>	<p>2 V p-p C4 shorted</p>	

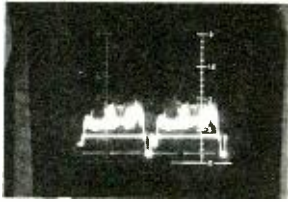

WF3 Normal 10 V p-p

Taken at the collector of X1, this is the output waveform of the transistor amplifier. Actual amplitude depends on R7. Shaping circuits at the emitter sharpen video sync. Notice the extra pulse on the pedestal back porch; leftover burst has been integrated.

R6 open R7 open C3 open		R3 open, high R4 open, low R8 open, low R9 open C1 shorted C3 shorted L2 open L3 open DL open X1 faulty	5 V p-p R1 high	1.5 V p-p R1 open	13 V p-p R3 low	3 V p-p R4 high	
			8 V p-p R8 high	13 V p-p C4 shorted	10 V p-p DL open	1.5 V p-p X1 faulty	

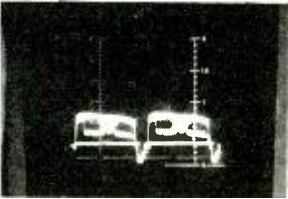

WF4 Normal 8 V p-p

Taken at the output of the stage, at test point A, this waveform has been acted upon by DL and the output peaking coils. Overshoots are subdued. Polarity remains sync-negative, as the common-emitter stage inverted it. Another stage inverts it again for the crt cathodes.

R6 open R7 open C3 open		R4 open, low R8 open, low C3 shorted L2 open L3 open DL open	4 V p-p R1 high	2 V p-p C1 shorted	13 V p-p R3 low	3 V p-p R4 high	
			6 V p-p R8 high	8 V p-p R9 open	10 V p-p C4 open	30 V p-p C4 shorted	

NOTES:

Use this guide and the Voltages Guide to help you pin down fault possibilities. Use the direct probe of the scope. Set the scope sweep to about 8 kHz, to display two pulses of horizontal sync. Check the four waveforms at the four key test points.

Collector voltage travels through R8 from the 18-volt dc supply line. Another path exists through R9, L3, DL, and L2. That path is coincidental, a result of R8 and R9 having to terminate identically. C4 blocks any dc path from X1 to the stage that follows.

Station and Control Effects

Altering the setting of R7, the CONTRAST control, has no effect on dc operation of the stage. Turning the pot does, naturally, vary video level in the output—WF3 and WF4. Fully clockwise, R7 allows output amplitudes about 50% higher than those shown. At minimum, fully counterclockwise, output amplitude is barely measurable.

With no station, there is no input or output video signal. Dc levels change somewhat, because of the direct coupling from the stage preceding. If the input were coupled capacitively as the output is, station signals would not alter dc op-

Note amplitude. If it's low or high, check the parts listed under those columns.

Note waveshape. If there's a change that matches one of those shown, check the part or parts indicated for the change you find.

eration in any way at all.

Quick Troubleshooting

Your scope gives you the best advantage in this stage. Touching the probe to the input and output tells you whether the transistor amplifies. Be sure the CONTRAST control is turned up.

Clip your scope probe to the junction of R3 and R4. Run the CONTRAST control all the way to both ends. With R7 fully clockwise, the scope display should be almost nil. With R7 turned down, amplitude should be about the same as RF2. That tells you whether the pot and capacitor (C3) are OK.

Faults in the delay line generally show up as double images on the picture-tube screen. But an open delay line can block video altogether in most chassis. The brightness or Y signal can't get through to operate the picture tube.

Dc measurements give limited clues.

R-E



Field Operations- the Technician's Role

Mostly out-of-doors, often in far-away-places, the electronics field technician or engineer is a new breed of man with unusual skills and a love for adventure.

by L. L. FARKAS

ONE OF THE MOST FASCINATING AND REWARDING WORK AREAS for electronic technicians is in field operations. Nowhere else can you find the variety of tasks, the different surroundings, the contact with so many people.

Radio/TV technician

Take the technician working for a radio or television station. He attends baseball and football games, tennis matches, athletic meets, boxing events, horse or ski races, even the Olympics. Sure he has to work when he's there, but can you think of more interesting conditions?

Basically he works with microphones, television cameras, audio and video mixers and amplifiers. He may also use portable transmitters and receivers. He sets up this equipment and checks it in the field to make sure it works and, when necessary, make emergency repairs. He has to run this equipment when the show goes on the air, and then tear down his set-up and pack the equipment for return to the station. But he isn't tied down to a 9 to 5 office job; he sees interesting events, meets all kinds of people, travels to many places. It may wear him down but he is never bored with his job!

The missile and satellite technicians are field men whose work is not only exciting but whose efforts can help make history. From the launching of the first man-space flight to the latest moonwalk, field technicians are in on the many phases that add up to a successful flight. Here field technicians work with equipment of the latest design, using the newest techniques. They are in daily contact with space engineers and astronauts, all intent upon making hardware and software work

perfectly. Whether the task is firing a missile which is controlled to fly a predetermined path, launching an instrumented vehicle to record upper-atmosphere data, or placing a manned laboratory into earth orbit, the field technician plays a part in each event. He checks the missile control system or the ordnance firing circuits to make sure that all parts are functioning correctly. He tests out the command links that control both missile and satellite functions, the telemetry that insures data being sent by the missile and received by the ground station, or the guidance system and flight computers that control the path the satellite travels through space.

Such circuits and systems are checked individually and then again in a simulated launch operation. The field technician is at the control console, or monitors specific equipment. As part of the actual vehicle launch he operates or monitors equipment during the space flight and subsequent return to earth, and finally, works with the engineers on the analysis of any launch or flight anomalies to prevent their recurrence in future flights. His work hours are usually long, because once a flight countdown begins it continues to the end unless halted by difficulties. In that case he helps troubleshoot the problem and makes necessary repairs. But he is engaged in a complicated and exciting venture in which the goal is a successful launch and safely-completed flight. He is in the forefront of important happenings, privileged to witness and be active in the dramatic progress of interplanetary flight.

Radar technicians

Working on radars is another engrossing job. There is of
(continued on page 50)

CIE graduate builds two-way radio service business into \$1,000,000 electronics company!

How about YOU? Growth of two-way transmitters creates demand for new servicemen, field and system troubleshooters. Licensed experts can make big money. Be your own boss, build your own company. And you don't need a college education.

Two-way radio is booming. There are already nearly seven million two-way transmitters for police cars, fire department vehicles, taxis, trucks, boats, planes, etc., and Citizens Band uses. And the number keeps growing by the thousands every month. Who is going to service them? You can — if you've got the know-how!

Why You'll Earn Top Pay

One reason is that the United States Government doesn't permit anyone to service two-way radio systems unless he's *licensed* by the FCC (Federal Communications Commission).

Another reason is that when two-way radio men are needed, they're *really* needed! A two-way radio *user* must keep those transmitters operating at all times. And, they *must* have their frequency modulation and plate power input checked at regular intervals by licensed personnel to meet FCC requirements.

As a licensed man, working by the hour, you would usually charge at least \$5.00 per hour, \$7.50 on evenings and Sundays, plus travel expenses.

Or you could set up a regular monthly retainer fee with each customer. Your fixed charge might be \$20 a month for the base station and \$7.50 for each mobile station. Studies show that one man can easily maintain at least 135 stations—averaging 15 base stations with 120 mobiles! This would add up to at least \$12,000 a year.



Edward J. Dulaney, Scottsbluff, Nebraska, (above and at right) earned his CIE Diploma in 1961, got his FCC License and moved from TV repairman to lab technician to radio station Chief Engineer. He then founded his own two-way radio business. Now, Mr. Dulaney is also President of D & A Manufacturing, Inc., a \$1,000,000 company building and distributing two-way radio equipment of his own design. Several of his 25 employees are taking CIE courses. He says: "While studying with CIE, I learned the electronics theories that made my present business possible."

Be Your Own Boss

There are other advantages, too. You can become your own boss — work entirely by yourself or gradually build your own fully staffed service company. Of course, we can't promise that you will be as successful as Ed Dulaney, or guarantee that you'll establish a successful two-way radio business of your own, but the opportunities for success are available to qualified, licensed men in this expanding field.

How To Get Started

How do you break in? This is probably the best way:

1. Without quitting your present job, learn enough about electronics fundamentals to pass the Government FCC exam and get your Commercial FCC License.
2. Then get a job in a two-way radio service shop and "learn the ropes" of the business.
3. As soon as you've earned a reputation as an expert, there are several ways you can go. You can move *out* and start signing up and servicing your own customers. You might become a franchised service representative of a big manufacturer and then start getting into two-way radio sales.

Cleveland Institute of Electronics has been successfully teaching Electronics for over 37 years. Right at home, in your spare time, you learn Electronics step by step.

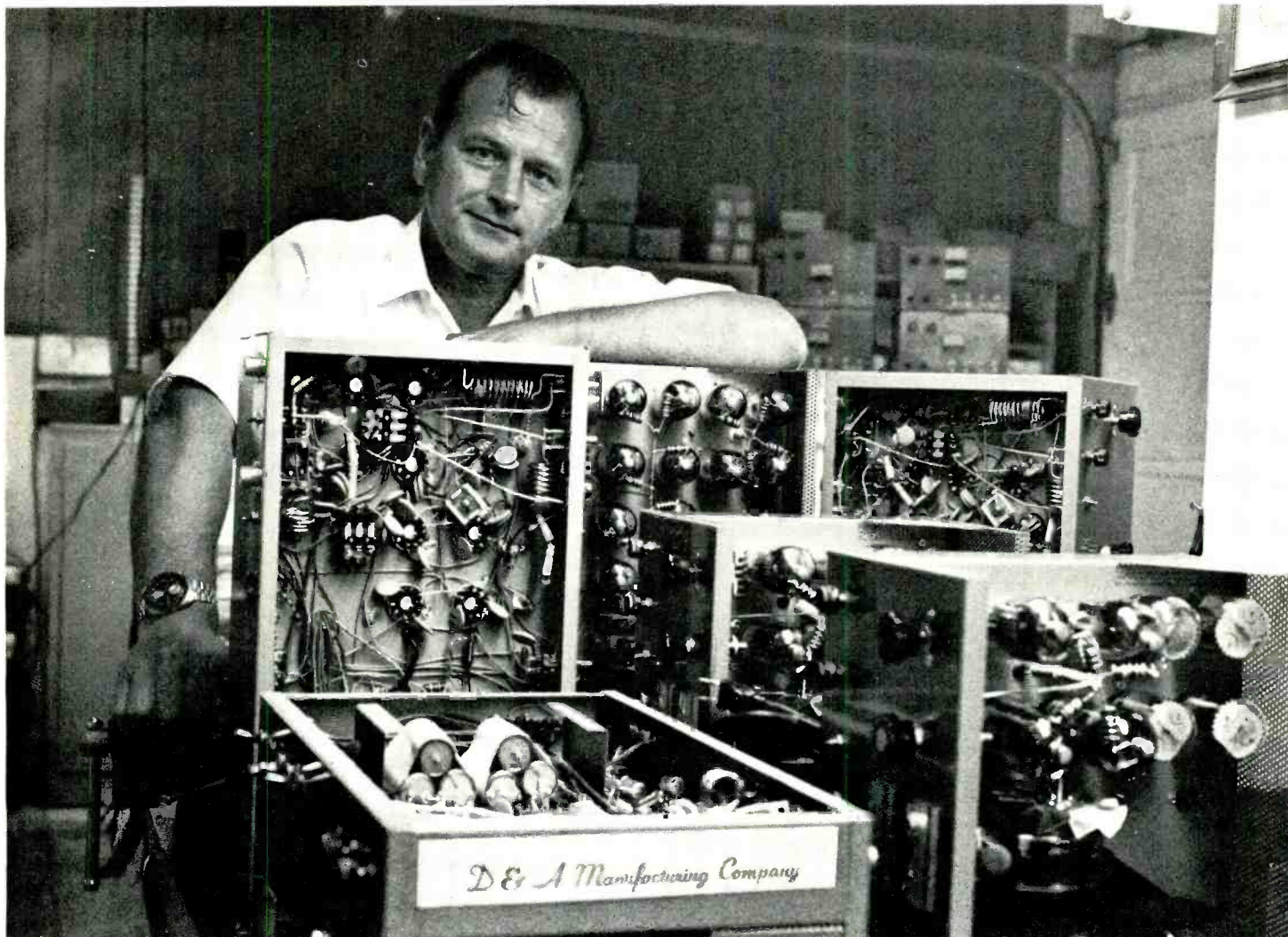

CIE's AUTO-PROGRAMMED® Lessons remove the roadblocks by using simple, concise examples. You learn in small, compact steps – each one building on the other!

You'll learn not only the fundamentals that apply to all electronics design and servicing, but also the specific procedures for installing, troubleshooting, and maintaining two-way mobile equipment.

You Get Your FCC License ... or Your Money Back!

By the time you've finished your CIE course, you'll be able to pass the FCC License exam. A recent survey of 787 CIE graduates reveals that better than 9 out of 10 CIE grads passed the FCC License exam. That's why we can offer our famous Money-Back Warranty: when you complete any CIE licensing course, you'll get your FCC License or be entitled to a full refund of all tuition paid. This warranty is valid during the completion time allowed for your course. You get your FCC License – or your money back!

It's Up To You

Mail the reply card for two FREE books, "Succeed in Electronics" and "How To Get A Commercial FCC License." If card has been removed, mail coupon or write: Cleveland Institute of Electronics, 1776 E. 17th Street, Cleveland, Ohio 44114.

APPROVED UNDER G. I. BILL

All CIE career courses are approved for educational benefits under the G.I. Bill. If you served on active duty since January 31, 1955, OR are in service now with more than 180 days of active duty, check box for G.I. Bill information.

CIE Cleveland Institute of Electronics

1776 East 17th Street, Cleveland, Ohio 44114

Please send me your two FREE books:

1. Your book on "How To Get A Commercial FCC License."
2. Your new catalog "Succeed In Electronics" describing the job opportunities in Electronics today, and how your courses can prepare me for them.

I am especially interested in:

- | | |
|---|--|
| <input type="checkbox"/> Electronics Technology | <input type="checkbox"/> Electronic Communications |
| <input type="checkbox"/> Broadcast Engineering | <input type="checkbox"/> Industrial Electronics |
| <input type="checkbox"/> First Class FCC License | <input type="checkbox"/> Electronics Engineering |
| <input type="checkbox"/> Electronics Technology with Laboratory | |

Name _____ (Please Print)

Address _____

City _____

State _____ Zip _____ Age _____

Veterans & Servicemen: Check here for G. I. Bill information
Accredited Member National Home Study Council

RE-05

Circle 11 on reader service card

course the experimental phase when new radars developed in the laboratory are installed on test sites and checked to determine their performance. Here field technicians install the equipment, perform tests, troubleshoot and repair defects, and may even instruct personnel in the operation and maintenance of the radar. There is a great deal of satisfaction in producing a good radar test run, or developing a performance pattern.

Field technicians also work on production radars, which perform many functions. They are used at airports to detect incoming and outgoing aircraft, and as ground control approach (GCA) equipment to guide airplanes during blind-flying conditions. Radars are also installed on planes and boats to facilitate navigation; used by the police to check the speed of automobiles on highways; and by the Weather Bureau to detect rain clouds and storms. These radars are generally installed by field technicians who often service the equipment later on. In this work the technician travels to the radar site to check, repair, and maintain the hardware.

The development of communication equipment is challenging work. The testing of transmitters and receivers of various frequencies over different conditions of terrain, range, and weather can keep technicians working in the field for many days. When this testing is coupled with antenna and transmission research, it is exciting and satisfying.

I recall, back in 1946, performing microwave transmission tests that required round-the-clock monitoring of radio signals on communications equipment in such places as San Diego, on the hills back of La Jolla, atop a cliff on Catalina Island, on a mountain peak in the Sequoia National Forest, and at the Presidio in San Francisco. It was during this series of tests that the use of the diversity antenna system was developed. Today microwaves span the country and the many relay stations are checked and maintained by field technicians. And how about the gigantic network of stations located around the world to monitor and record space data and act as communication relays to contact the astronauts of our space flights? Here again field electronic technicians play an important role in testing, running, and maintaining the many complex racks of equipment that make up the complete global system.

Military field training

The military services train many types of field electronic technicians. Men set-up, operate, and maintain surveillance radars, anti-aircraft gun-control radars, vehicle and personnel detection systems. Technicians man GCA sets and air control equipment, and handle missile systems. They also operate and maintain ship and airborne radars, communication systems, and other electronic gear. They even take care of submarine electronic equipment. And whenever a new electronic system is developed for military use, they're the first ones to be trained in its theory, operation, and maintenance. This training and experience is often useful later in obtaining a job as a field technician in civilian life.

Do you qualify . . . ?

As field work differs from in-plant work, the personnel requirements are also more stringent. The electronic technician assigned to a field job must thoroughly understand the equipment on which he is to work. Theoretical knowledge is not enough. He must have experience with the hardware also. This is so important that any technician who is not familiar with all the details of the theory, operation, repair, and maintenance of his assigned equipment should not travel to the field. Most companies know that and they insist that prospective field men pass detailed technical courses on hardware. They often assign these men to in-plant test work on the same equipment before they send them out to the field.

In addition, the good field technician also knows quite a bit about associated work areas. For example, he may be an expert on communications equipment, but this knowledge



AUTHOR ADJUSTS PARABOLIC MIKE for a football game pickup. A typical job for a technician for a TV or broadcast station. Other remotes include fires, natural disasters and major emergencies.

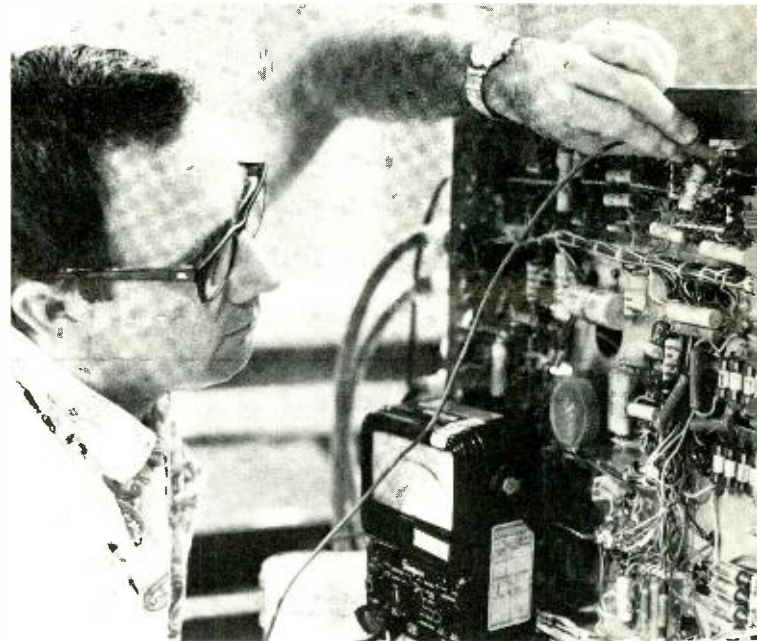

FIELD TECHNICIAN TROUBLESHOOTING CCTV CHASSIS. Work is similar to ordinary servicing but is often done under emergency around-the-clock conditions with a minimum of test equipment.

won't help him repair a defective generator that feeds the equipment. In the field, perhaps thousands of miles from his home plant and technical help, the field technician must rely almost entirely upon his own knowledge and experience. The wider that background is, the easier for him to solve the problems that arise. He may have to rewind a coil, construct a make-shift relay, weld or machine a broken part for which he can get no immediate replacement: all these may be needed to keep critical equipment operational. The ability to apply his knowledge to meet various situations not only make the field man a more valuable employee, but give him the self-confidence and reliability that will go a long way toward improving his chances for advancement.

Another requirement is good physical health in order to withstand long hours of work in various climates and elevations. Bear in mind that a field man may be working in a

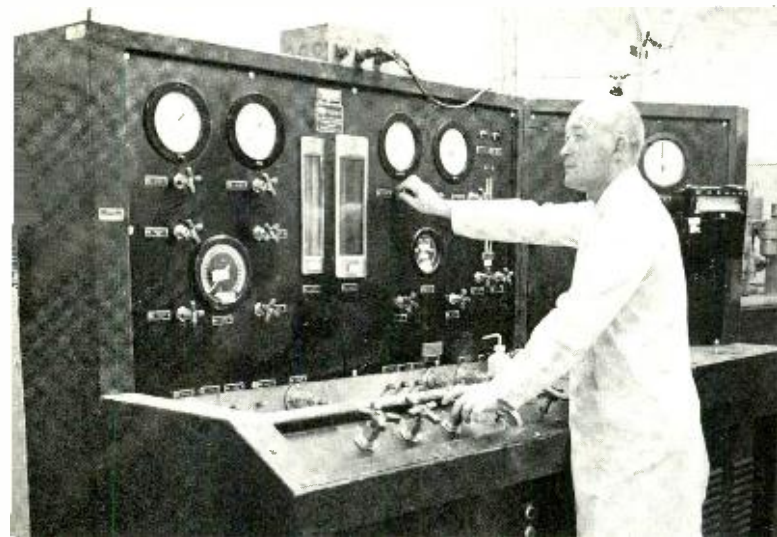

FIELD CALIBRATION TECHNICIAN checking a hydraulic console in a part of an operation by Martin Marietta Corporation.

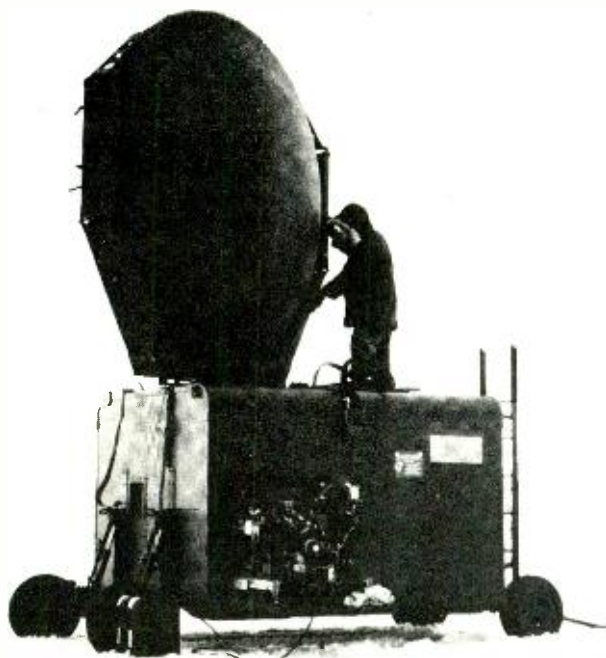

FIELD TECHNICIAN SETTING UP COMMUNICATIONS EQUIPMENT in a Martin Marietta Corp. operation in the far reaches of Alaska.

desert, on a mountain peak, or in a swamp. The temperature may be 120° or -40° and he may encounter sandstorms, snow and ice, fog, or tropical downpours. He may have to carry heavy equipment on his back, load it into a helicopter, or steady it into a rocking boat. To do all these things with minimal chance of harming himself, he must be free of back ailments; nor should he have a heart condition, however slight, or be diabetic, because the exertions of field work may bring on an attack which can easily become fatal should it occur in an area far from immediate medical attention. Even such things as a tendency toward respiratory diseases, or allergies, can cause trouble in the field. That's why the field technician should be in as good a physical shape as possible.

Just as important is the man's mental state. First, he must like field conditions and be able to adapt readily to the different environments in which he may work. The long arduous

winters in the Arctic; the insects, the humidity, and heat of the tropics; the wind and sand of the desert: all these can affect a person's mental outlook until his work suffers. Even if those conditions are not present, field jobs are often located in remote areas far from cities, so that the field man must be able to get along with people and especially his fellow workers, not only on the job but during off hours. Remember that a field crew is a close-knit organization. On the job the men depend upon each other, each one being responsible for his part of the job. One worker too upset to do his task can upset all the others and disrupt a complete field operation. During off hours men cannot easily avoid the others: they are generally housed in the same barracks; they eat together; and they often participate in the same recreation. This is where maturity is invaluable. The calm self-subsistent person can readily adjust to this togetherness, but a less stable man may get into trouble with drugs, by excessive gambling or drinking or even "going-native."

To enrich the leisure time of their field technicians many companies provide study and other types of programs. These courses serve the serious person as a means of increasing his education and advancing in his work. One company encourages such study by offering the field technician who successfully completes a series of work-relevant courses, a job either in a better location or closer to his family, as well as more money.

An advantage of field work is that it generally pays better than an in-plant job. Housing, if not company-provided, is usually available at a fairly low rate. This is especially true if government housing is furnished on a military post or other Federal area. Food can also be cheaper in field locations. If the field man budgets his income he can build up a nest's egg for paying off the mortgage on his home; buying new furniture, a new car or boat; or buying that mountain cabin he will use during his retirement.

Some advantages to field work

But more important than money, perhaps the greatest advantage of field work is the range of experience it provides. One company makes it a practice to send its design engineers to work in the field for one year. Many of these men complain, insisting that it will be time wasted from their specialty. But of all those engineers who went to the field, none returned without admitting that he had learned more in that one year than he could possibly have at the drawing board. Most of these "exiles" learned how well or how poorly his designs work in the field. They experienced the problems of placing equipment in operation under field conditions; saw the weakness and defects of parts and systems, and determined the repairs and maintenance needed to keep the equipment running.

The field technician is in daily contact with these essential factors. An alert and conscientious man can really learn his craft. This is why, given two men—one with and one without field experience (all other things being equal)—the smart supervisor will invariably hire the electronic technician with field experience.

One final word must be said about field work. It is a social experience. Living in a distant land or state is not only pleasant but educational. The field man learns how other people live, and their language customs. He can make many new friends. When his family can be brought along, all of its members share an enriching experience to treasure for a lifetime.

Field operations furnish the electronic technician with interesting work in different surroundings, increase his experience and update his technical education. He can make and save money at a quicker rate than local living generally permits. And it provides him with an enjoyable and broadening sojourn among different people. It is no wonder that many electronic technicians want to work on a field operation.

R-E

Build OP-AMP

Apprentice or journeyman, engineer or experimenter, all will need an extra meter at one time or another. Try this op-amp IC multimeter to have on hand next time you need a spare.

Multimeter

by B. R. ROGEN

NOW THAT YOU HAVE BEEN INTRODUCED to the op amp, and have experimented (we hope!) with some of the small circuits shown last month, you may like to see how to make a first-class multimeter that rivals most of the commercial units found today, yet will cost only a small fraction of their price. It is completely battery powered and the number of ranges is strictly up to you.

The multimeter Fig. 1 can measure voltages between 1 mV (.001 volt) and 300 volts, and currents between 1- μ A

and 300 mA. The input impedance is 1 megohm per volt on the ranges up to 30 volts. Voltage drop across the input terminals, when using the multimeter to measure current, is 1-mV on the 1- μ A range, and rises to a maximum of 10 mV on the 300-mA range. Amplifier drift and noise are negligible after a 5-minute warm-up period, and temperature coefficient is about $5 \mu\text{V}/^\circ\text{C}$.

The accuracy depends on the precision of the resistors used in the two divider networks. For maximum accu-

racy, these should be 1% types of either high-stability carbon or metal film. Do not use metal oxide types—these sometimes have a large thermoelectric effect that can reduce accuracy.

How it works

The two FET's, Q1 and Q2, reduce the level of input current to the op amp. A matched pair of FET's is required in this circuit. The amplifier loop gain is determined by the network made up of R36, R37 and R38, and R32 is the zero

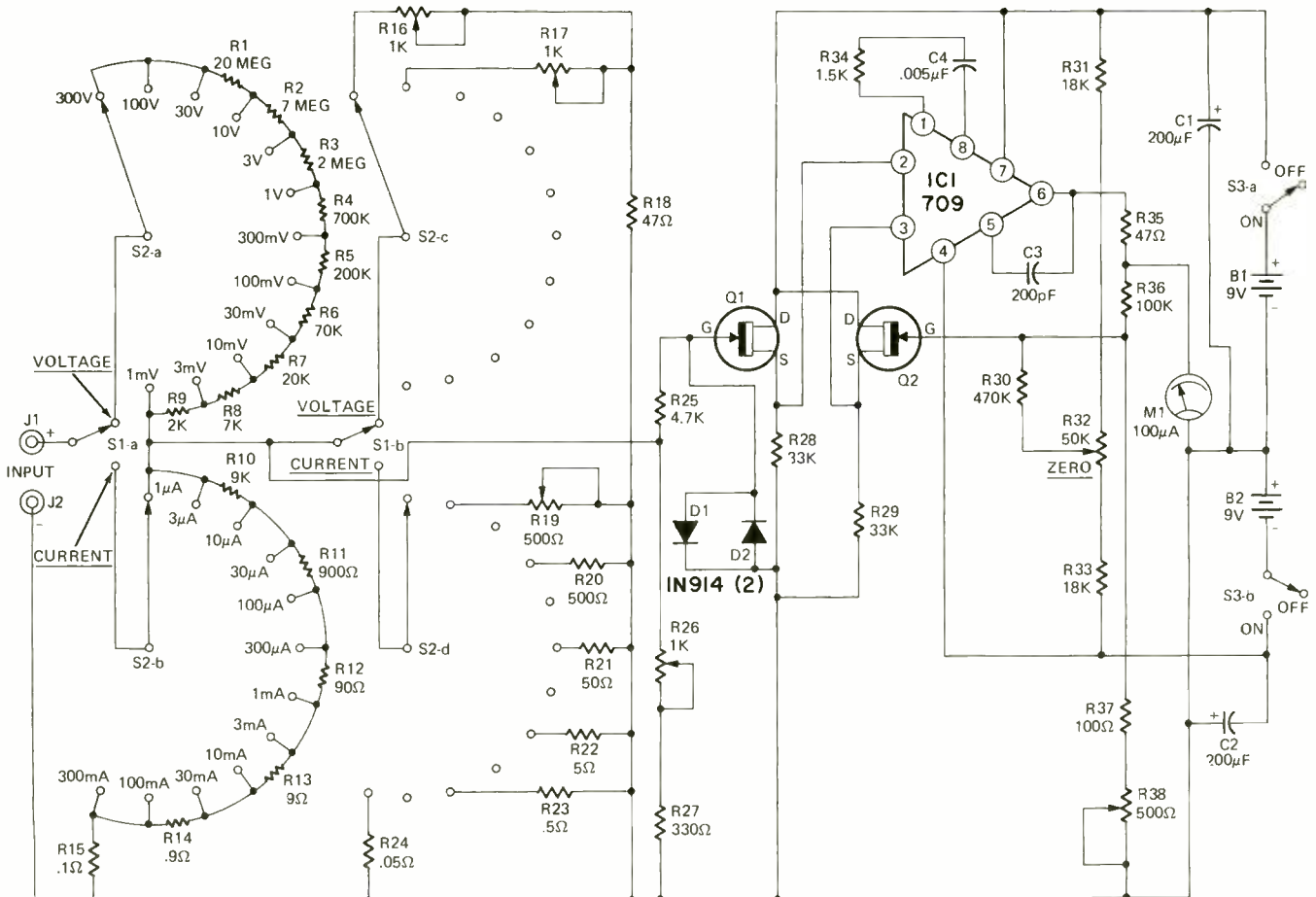

FIG. 1—ONE SWITCH SELECTS either the voltage or current mode; the other covers the ranges in both modes. The instrument measures voltages from 1 mV to 300 V and currents from 1 μ A to 300 mA. Adjustments are simple.

adjustment. The op amp is frequency-compensated by R34 and C4, and C3. The circuit is protected against excessive (damaging) inputs by diodes D1 and D2.

Construction

The electronic circuitry can be built up on perf board, or a PC board layout can be designed. The layout is not critical, except for making sure that the compensation components, also C1 and C2, are mounted as electrically close to the op amp as possible.

The circuit board is mounted within a metal chassis for shielding. All components of the two divider networks (except for the three potentiometers) are mounted directly on the associated switches, RANGE switch S2, VOLTAGE-CURRENT selector switch S1, and ZERO adjust potentiometer R32 are mounted on the front panel—along with power switch S3, and two input five-way connector jacks.

Resistors R15 (.1 ohm) and R24 (.05-ohm) are fabricated from conventional resistance wire, and an accurate ohmmeter should be used when trimming the wire to the closest correct

value. If you happen to make the wire a trifle too low in resistance, scrape it with a file till it reaches the correct value.

Calibration

This requires a low-ripple power supply that can deliver 300 mA at 10 and 30 volts, and 1 mA at 100 and 300 volts. A known accurate dc voltmeter may be used (or borrowed) to make the necessary voltage adjustment.

Use the circuit shown in Fig. 2-a to calibrate the 1-mV range. Set S2 to the 1-mV range and set S1 to the VOLTAGE

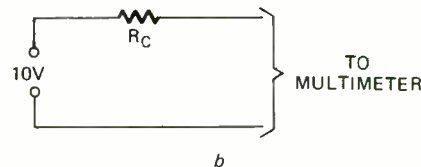
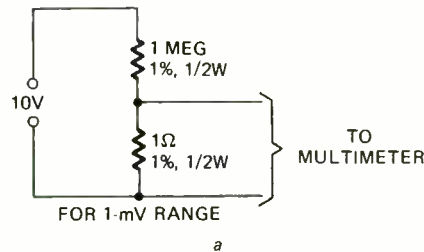

$R_C = 10 \text{ MEGOHM FOR } 3\mu\text{A RANGE}$
 $= 100\Omega \text{ FOR } 100 \text{ \& } 300\text{-mA RANGE}$

FIG. 2—TWO SIMPLE NETWORKS are all that is required to calibrate the multimeter.

position. With no input, turn on the power (via S3) and adjust R32 for a meter zero. Connect the multimeter to the test circuit.

Adjust R38 for full-scale deflection of the meter. This insures that 1 mV fully drives the meter circuit.

Set S2 to the 10-volt range, and connect the dc test source of 10 volts direct to the multimeter input, using the circuit shown in Fig. 2-b but without a resistor. Adjust R26 for full-scale meter deflection. This adjustment corrects the overall value of the potential divider and shunt networks.

Set S2 to the 100-volt range, and use a 100-volt dc power supply with no resistor in series. Adjust R17 for full-scale meter deflection. Switch the function switch to the 300-volt range, use a 300-volt dc source and adjust R16 for full-scale deflection. These latter two adjustments further modify the input networks for correct operation. Turn off the dc power source.

Set the function switch to the 3- μA position, set S1 to the CURRENT position, and use the test circuit shown in Fig. 2-b, using a 10-megohm resistor as R_C , and 30 volts as the source. Adjust R19 for a full-scale deflection.

Using the circuit of Fig. 2-b, a 10-volt power source and a 100-ohm resistor for R_C , set the function switch to the

100-mA position and turn on the power supply. The meter should indicate full scale if R15 was trimmed to the correct value. If the meter is not very close to full scale, then R15 will have to be trimmed again. If the needle is above the maximum marker, the resistance of R15 is too high. If below full scale, R15 is too low. Adjust accordingly as previously described.

Again using Fig. 2-b, but this time with a 30-volt dc source and a 100-ohm resistor for R_C , set S2 to the 300-mA position. The meter should indicate full scale. This is determined by R24, and should be adjusted the same as R15. **R-E**

SHOE DYE RESTORES SPEAKER GRILLE

After overhauling an old TV set you can restore that like-new rich tone to a faded speaker grille cloth by swabbing it with brown shoe dye. To



get an even tone be sure to dip the dauber into the dye frequently so that you saturate the cloth.—Gene Cabot **R-E**

PARTS LIST

- R1—20 megohms, 1%
- R2—7 megohms, 1%
- R3—2 megohms, 1%
- R4—700,000 ohms, 1%
- R5—200,000 ohms, 1%
- R6—70,000 ohms, 1%
- R7—20,000 ohms, 1%
- R8—7,000 ohms, 1%
- R9—2,000 ohms, 1%
- R10—9,000 ohms, 1%
- R11—900 ohms, 1%
- R12—90 ohms, 1%
- R13—9 ohms, 1%
- R14—.9 ohm, 1%
- R15—.1 ohm, (see text)
- R16, R17, R26—1000-ohm pot
- R18—47 ohms, 1%
- R19, R38—500-ohm pot
- R20—500 ohms, 1%
- R21—50 ohms, 1%
- R22—5 ohms, 1%
- R23—0.5 ohms, 1%
- R24—.05 ohms (see text)
- R25—4,700 ohms, 5%
- R27—330 ohms, 1%
- R28, R29—33,000 ohms, 1%
- R30—470,000 ohms, 5%
- R31, R33—18,000 ohms, 5%
- R32—50,000-ohm pot
- R34—1,500 ohms, 5%
- R35—47 ohms, 5%
- R36—100,000 ohms, 5%
- R37—100 ohms, 5%
- C1, C2—200- μF , 16-volt electrolytic
- C3—200-pF disc
- C4—.005- μF disc
- D1, D2—1N914
- IC1—709 op amp
- J1, J2—5-way binding posts, one red (+) one black (-)
- M1—0-100- μA meter
- Q1, Q2—TIS70
- S1—dpdt switch
- S2—four-pole, 12-position rotary switch
- S3—dpst switch

Perf or PC board, battery holders and connectors, metal chassis, knobs, mounting hardware, etc.



Herbert! Can't you forget for just two weeks that you're a TV service technician.

SUPERCLOCK—

Premium quality digital clock
time-zone conversion,
individualized pack-

A WIDE RANGE OF ELECTRONIC DIGITAL clocks is available today. These run from \$5 drugstore flip-flip-flip novelties through \$50 to \$100 surplus TTL jobs up through manufacturer's prototype digital timepieces costing many thousands of dollars. The vast majority of them are hard to build, difficult to set, lose their time on a momentary power dropout, and cannot be adapted to automatic pushbutton timezone conversion, 12-24-hour operation, or to making themselves self-resettling and always accurate by using National Bureau of Standards time code services.

Not so with the **Radio-Electronics Superclock III!** Here is an attractive, up-to-date digital clock that gives you any even-hour time zone in the world *instantly* at the press of a button. This plug-in modular unit uses only *eight* integrated circuits, for high noise immunity and easy assembly. It presents its time on low-voltage, highly attractive 28-dot Light Emitting Diode (LED) displays. It accepts *either* time pulses *or* a time code, or both simultaneously. Thus, you can use virtually *any* source of timing information. By adding one of a number of suitable adapter plug-ins, you can set up a *direct digital display of National Bureau of Standards time*, either as broadcast, or converted to your local 12-hour time or any other time zone in the world.

For instance, you can use two IC's to form a conventional "me-too" power-line divider just like anybody else. Or, you can go to a 1-MHz crystal and *single IC* divider that gives you one second per day quartz stability along with your choice of setting speeds, 1 pulse per second, or one pulse per minute out. If you want, this lets you run on battery power, or—by floating a battery across your power supply—you can eliminate any time dropouts and keep constant, accurate time during a power outage.

Better still, you can build a time decoder for any of the widely available National Bureau of Standards timing signals, load these into the clock in parallel, and *always* have *exactly* the right time, hands off and unattended.

One possibility is to use an ordinary communications receiver and a simple decoder that extracts the 100-Hz

subcarrier time code broadcast by WWV. (We'll show you how in a future issue). Or, if you live in the western United States, you can build a WWVB 60-kHz receiver and display the NBS 24-hour-a-day time code. Very shortly, you should be able to clip the Superclock III and a suitable decoder directly onto your TV set, and receive time signals broadcast by the networks. As soon as these signals are available on a permanent basis (tests have been going on for over a year), we'll show you how to use them for fully automatic, *always accurate* operation. Other somewhat more specialized time signals you can use include the Omega system, the NBS satellite system, and foreign equivalents to NBS broadcasts.

One good combination is a time base *and* a time decoder. This way, the Superclock runs as an ordinary clock till you send it a valid time code signal. If it has to, it then changes its time to match the code, and takes off from there. Thus, viewing one network television program or tuning in WWV once a day keeps you accurate forever.

About the circuit

Fig. 1 shows the schematic and parts list of the Superclock III main clock module. This single PC board measures 4¼ x 6¾ inches. It holds 8 IC's, including the time zone computer-on-a-chip and a six-station time-zone selector, along with the hours-minutes-seconds counters and displays. Forty pins worth of plug-in connector allows you to input serial time, a parallel time code, or get out signals for AM/PM, days counting, and expansion to more than six time zones. Internal program jumpers on a clearly marked and well arranged "program bay" let you pick either 12 or 2400-hour operation of the basic clock. Power requirements are 5 volts at 700 mA and -12 volts at 25 mA—the latter needed only for time zone conversion.

We'll look into this module first. Then we'll look at details on a dual-time-base/AM-PM module and finally some case, power supply, and setting details. In future issues, if enough readers are interested, we'll talk about the WWV receiver, the television time receiver, and maybe some of the more specialized add-ons.

The seconds counter consists of

conventional cascaded divide-by-ten and divide-by-six counters. The counter IC's selected have both parallel and serial entry. This means you can either count input pulses arriving at a 1 pps rate, or you can parallel load a time code word at the proper time for an exact update. *Reset* and *Load* lines are individually brought out. External connections to these must be short and low-capacitance. Bringing the *Reset* line briefly to ground sets the seconds to 00. Briefly grounding the *Load* input preloads a selected number into the counter. For instance, the WWVB code is "ready" 20 seconds after each minute with a typical decoder; you thus parallel-load the correct hours and minutes words into the hours and minutes counter and a "20" into the seconds counter, doing so twenty seconds after every minute, thus compensating for the necessary decoder processing time. WWV reception usually is ready "30" seconds after each minute, while the TV time code can be made ready either on the minute, every ten seconds, or every second, depending upon the decoder complexity. The outputs of the seconds and ten seconds counter go directly to the seconds readouts, which carry their own internal latch and decoder. The "40 seconds" digital output is brought off the board. Normally it is cascaded to the "minutes" input, except during setting times.

The readouts are *Hewlett Packard* 5082-7300's. They are 0.3-inch high and present an attractive 28-dot bright red character. Since they have their own internal latching and decoding, they greatly simplify the rest of the clock. They are socket mounted.

The minutes counters are identical to the seconds counter. The minutes counter is normally driven from the seconds carry except during setting, so it has its own input pin brought off the board. This also lets you run without seconds for low cost. If you don't want seconds, you leave the seconds counters but not the readouts in place if you're using a line-operated time base. With the crystal time base, you can get the 1 ppm *directly* out of the time base chip, and delete the seconds portion of the circuit entirely. Either way saves cost.

The minute counters drive their own readouts directly. *Reset* and *Load* inputs are brought out separately for

NEW DIGITAL TIMEKEEPER

offers instant pushbutton
12-24-hour capability, easy assembly,
aging

by DON LANCASTER

decoders that provide a minute update at a time different than the hour update. If you are not using any time base, all the counters, hours, minutes, and seconds, serve simply as storage latches. While this is also obviously cheaper, it presents the right time *only* when a valid code is received by a decoder. In this mode, you have to be *continuously* receiving time signals for a valid display. With the time base, all you need is an occasional (once per day) valid update, with automatic fill-in being provided between update times.

The hours counter operates in two distinct modes, one for 12-hour operation and one for 2400-hour operation. Program jumpers decide which mode your clock will be in. For local time only, you can pick between 12 or 2400-hour, but if you want a GMT display or if you are using a WWV or WWVB receiver, the clock **MUST** be in the 2400-hour mode. The time zone chip will then convert to give you your local 12-hour time. The TV time system requires a 12-hour counting mode.

The hours counter consists of a divide-by-ten and a "0-1" or "0-1-2" counter. A three-input gate (IC7) decodes the required time to shorten the count sequence as needed in each mode. The time through the gate is long enough to insure that a self-annihilating coincidence or a partial reset cannot occur.

In the 12-hour mode, the "1" output and its parallel input are *inverted*. Now, the counter resets to state "1" instead of state "0", but otherwise still counts in the usual way as an ordinary decade counter does. The three-input gate detects state "10 and 2 and 1", automatically shifting the counter from a 12:59 count to 1:00. In the 2400-hour mode, state "20 and 4" is decoded, but the inverters are *not* used, automatically going from 23:59 to 00:00 on the next minute.

Load (L) and *Reset RST*) lines are brought out, and the "40 minute" output directly drives the "hours count" input. A "2" and a "10" output is also brought off the board—useful for AM-PM and day counting. This lets the day and the AM-PM change one minute after 11:59, unlike the counter reset which takes place one minute after 12:59. An external jumper between the gate and the hours reset must be provided.

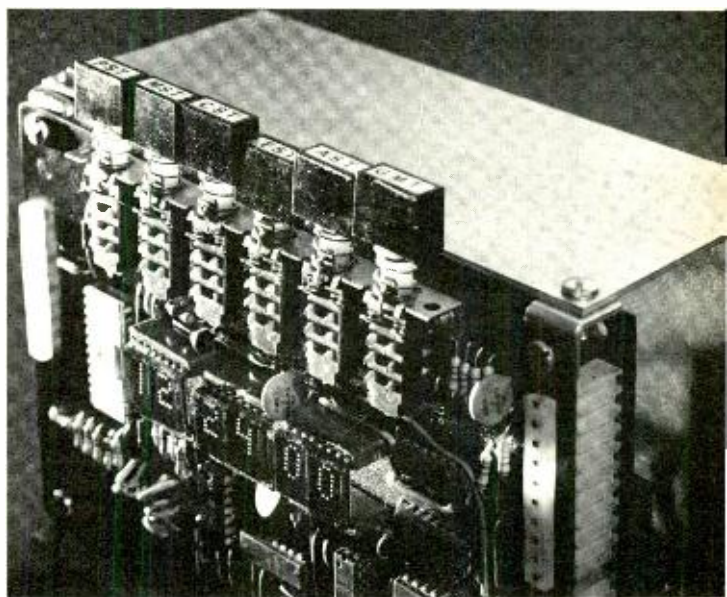

In an ordinary 12-hour, serial input digital clock, the two counters "left over" in the ten second and ten minute slots may be used for the "10 hour" and "AM-PM" counters. This cannot be done if you need the parallel update capability and if you need a 20-hour counter. Thus, the apparently "extra" IC6 is definitely needed in the Superclock III to allow its performance extras.

It is easy to convert from 12 to 2400 hours by changing the five program jumpers in the programming block.

Time zone conversion

The single IC computer-on-a-chip time-zone converter in the Superclock III converts any 12 or 2400-hour time zone in the world into itself or any *other* 12 hour time zone, except for those few countries whose time is out of line with the rest of the world by 15 or 30 minutes. An improved version of the basic time zone IC also keeps track of AM-PM anywhere in the world.

Six pushbuttons on top of your clock can give you any U.S. time or GMT. Instantly and without disturbing the input time code. Or, you can expand to 12 or 24 buttons and get world-wide operation.

The time zone chip does such nice things as converting WWV's 2400-hour Greenwich Mean Time into your local 12-hour time, or shifts the West Coast time broadcast by the television time code to your own local time. It also gives you instant daylight saving time corrections. Hams and SWL's will find the combination of 2400-hour GMT and 12-hour local time on the same clock display particularly useful.



SUPERCLOCK UNDRESSED (top) to show interior. Circuit boards are joined through connectors. CABINET (above) is prototype. You'll want to design your own.

The cost of the Superclock varies with the options, but it generally runs less than double what you'd pay for a plain old *Nixie* surplus-TTL job. This, of course, is only a tiny fraction of the cost of any other available system that gives you an always accurate, self resetting NBS time display. As far as we know, this is the *only* system now available with instant single-IC time zone pushbutton conversion. Circuit boards, complete kits, time zone kits, cases, and all individual parts are available from at least one source as shown in the parts list.

The time zone conversion is handled with a MOS (Read-Only-Memory) computer-on-a-chip that automatically adds or subtracts the correct number of hours as needed. The chip has five time inputs, called "1", "2", "4 or 20", "8 or 20" and "10". These are connected to their respective terminals on the hours counter. An OR circuit formed of a resistor and a diode is used on both the "4 or

you can also think of this as *adding* 11 hours. Thus the same code position handles a -1 or +11 hour shift. 0010 subtracts two hours or adds ten; 0011 subtracts three hours or adds nine; and so on, up to 1011 which subtracts 11 hours or adds 1. Codes "12" through "15" (1100, 1101, 1110, and 1111) are not valid inputs to the computer and should not be used.

The IC8 chip has six outputs, "1", "2", "4", "8", "10" and "20 or AM-PM". Each output goes to its respective terminal on the hours or ten hours readout. Each output will drive the readout or one TTL standard load or one npn transistor. It cannot simultaneously drive both the readout and another TTL input. To use the chip, you simply punch the code you want on the select lines; it then automatically converts the input time to the output time, automatically taking care of addition, subtraction, carrying, borrowing, going from 12 to 1, subtracting 12 from high 2400 inputs etc. The chip may also be used on any other digital clock that has a Binary Coded Decimal (BCD) hours time code and TTL-compatible or MOS-compatible outputs. Thus, if you already have an ordinary digital clock, you can easily add only the Time Zone feature of the Superclock III if you want to.

The "20 or AM-PM" output serves two purposes. It is available only on

FIG. 1 (left)—THE MAIN CLOCK MODULE, schematic of the PC board. All program jumpers are shown in the 12-hour position.

FIG. 2 (above)—THE PRINTED CIRCUIT BOARD is made from 1/16-inch G-10 PC glass epoxy material.

FIG. 3—DRILLING GUIDE indicates four sizes of holes needed on PC board. Use dimensions when photographing foil pattern.

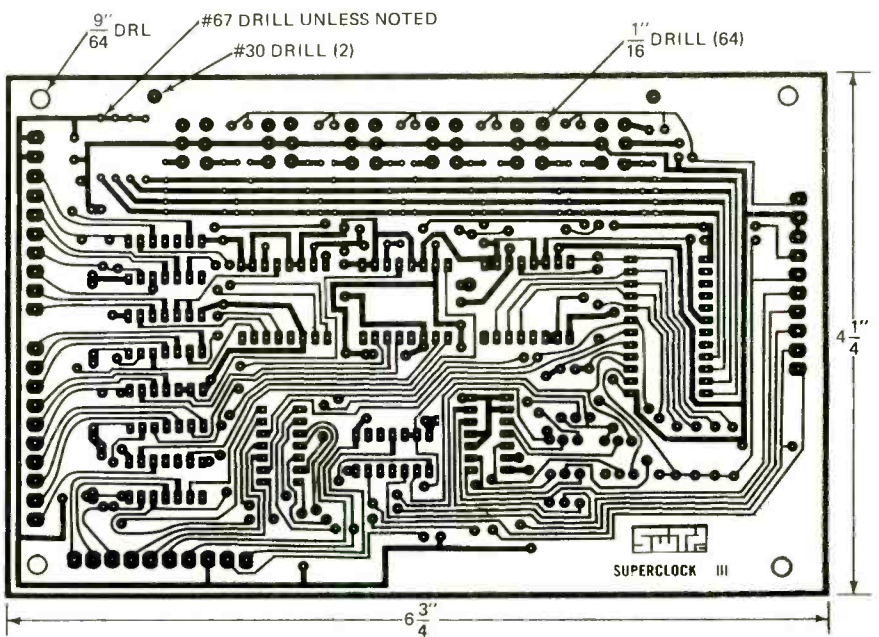
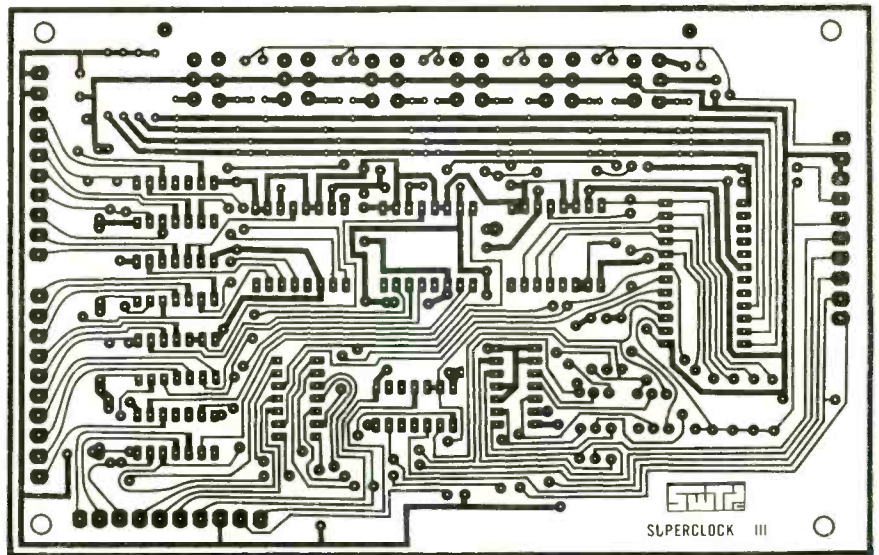

(MAIN CLOCK BOARD)

- R1, R2, R17, R19, R20, R21, R22—10,000 ohms
- R3, R23—220 ohms
- R4 to R8—470 ohms
- R9—1000 ohms
- R10 to R15—9,100 ohms
- R16—22,000 ohms
- R18—2,200 ohms
- All resistors 1/4-watt carbon.
- C1 to C4—0.1- μ F, 10-volt disc ceramic capacitor
- D1, D2—1N914 or similar silicon diode
- IC1, IC3, IC5, IC6—8280 TTL parallel load decimal counter (Signetics)
- IC2, IC4—8288 TTL parallel load base 12 counter (Signetics)
- IC7 5N7410 TTL Triple 3-input gate
- IC8—Time zone read-only memory (ROM) Southwest No. 4671
- J1 to J4—10-pin connector, modified Molex 09-57-1105
- Q1—2N5129 transistor
- RO1-6—LED readout with internal latch and decoder driver, Hewlett Packard 5082-7300
- S1—Six-station pushbutton selector assembly
- MISC.—No. 24 solid wire for jumpers; programming diodes, 1N914 (4); $6\frac{3}{4} \times 4\frac{1}{4} \times 1/16$ -inch printed circuit board; sockets or socket strips for readouts (8 sets of eight contacts each); mounting hardware for S3; solder. Sleeving for No. 24 jumpers

NOTE: The following parts are available from

Southwest Technical Products, 219 West Rhapsody, San Antonio, Texas 78216:
Front board No. CLM-b, \$8.75.

Complete front board with all parts including read-only-memory (ROM) and readouts. No. CLM-2, \$110.00.

Rear board for crystal time base etc. No. CLR-b, \$4.75.

Rear board with crystal, IC's, etc. No. CLR-2, \$22.75.

Power supply kit complete, No. CLS-2, \$12.50.

We have not provided a case for the clock because we have found that with projects of this type, the builder prefers to express his ingenuity by designing his own case or by building the device into existing equipment.

PARTS LISTS SUPPORT MODULE

(A) Crystal Timebase:

- R1—5.1-megohm, 1/4-watt carbon
- C1—20 pF mica
- C2—4-40 pF trimmer
- C3, C4—0.1 μ F, 10-volt disc ceramic
- IC1—MK5009 Timebase Divider (MOSTEK), a special design by and build for Don Lancaster for this project.

Xtal1—1.0 MHz xtal, parallel resonant into 32-PF load

(B) Line Timebase

- R1—4,700-ohm, 1/4-watt carbon
- R2—1,000-ohm, 1/4-watt carbon
- R3, R4—2,200-ohm, 1/4-watt carbon
- C1—220 μ F, 6-volt electrolytic
- C2—0.1 μ F, 10-volt disc ceramic
- C3—10 μ F, 10-volt electrolytic
- C4—1,000-pF disc ceramic
- D1—1N914 silicon diode

IC1—8288 Base 12 counter (Signetics)

IC2—8280 Base 10 counter (Signetics)

Q1—2N5129

(C) AM/PM Circuitry

- R1—10,000-ohm, 1/4-watt carbon
- R2—2,200-ohm, 1/4-watt carbon
- R3, R4—330-ohm, 1/4-watt carbon
- C1—0.1 μ F, 10-volt disc ceramic
- IC1—SN7474 Dual D flip-flop, TTL
- IC2—SN7486 Quad EXCLUSIVE-OR TTL
- L1, L2—Red LED panel lamp, Monsanto MV 5023 or equal
- Q1—2N5129 transistor

(D) Setting Circuitry and Connectors

- S01, 4—10-pin female connectors, Molex 09-52-3103
- C1—1 μ F, 10-volt electrolytic
- S1—spst slide switch
- S2, S3—spdt pushbutton
- Misc. mounting hardware
- Red Plexiglas front filter

BREADBOARDING DIGITAL CIRCUITS

Experimenting is the quickest way to develop an understanding of digital logic circuits and their application. All this is simplified by breadboarding.

by JACK CAZES



THE FIRST TWO PARTS OF THIS SERIES told how to build the *Digi-Dyna-Check* digital integrated circuit tester and how to use it for dynamically checking a variety of IC types, both in- and out-of-circuit. This was done by simulating actual operating conditions: that is, making the IC "do its thing". We've seen that the matrix programming switch allows us to set up any combination of input/output conditions readily. Thus, the *Digi-Dyna-Check* is virtually obsolescence-proof.

Now, let's see how to use this programming capability to "breadboard" some simple digital circuits, using readily available IC's. The matrix switch will provide "jumpers", or circuit-patch connections. It will also establish input and output logic levels. The 16 monitor lamps will, as before, indicate the logic states at all points in our circuits, *simultaneously*. The input-output binding posts will be used to patch in external circuits and test equipment—scope, oscillator, or other instrument. Matrix positions 7, 8, 9, and 10 will, therefore, be used both as jumpers and as connections to the "outside world" via their binding posts A, B, C, and D.

The circuits we're going to build should serve, merely, as examples of how to breadboard with the *Digi-Dyna-Check*, making full use of its matrix capability. Operating power will always be supplied to the IC by connecting its ground pin to Position 1 (GND) and its V_{cc} pin to Position 2 (+5V). Matrix sliders that correspond to pins that are not used in a given circuit are left in the NEUTRAL position.

The experiments have been divided into sets, to offer relatively simple, basic computer circuits (logic gates) first, memory devices (flip-flops) next, and finally, circuits that use com-

binations of several flip-flops to manipulate numbers (counters and dividers).

Gates

The basic logic circuits in digital computers are known as *gates*. Their output voltage may be low or high, depending on the voltage levels at their inputs. We have examined the various input-output combinations for the common gates in the second article in this series. These are summarized, for two-input gates, in the following *truth table*. A high level is represented by a "1" and a low level by a "0".

INPUTS		OUTPUTS			
A	B	NOT*	NAND	AND	OR NOR
0	0	1	1	0	0 1
0	1	—	1	0	1 0
1	0	—	1	0	1 0
1	1	0	0	1	1 0

*NOTE: The NOT gate, or INVERTER, as it is usually called, has only one input. The output logic state is always the opposite of that which is present at its input.

These gates can all be synthesized with combinations of 2-input NAND gates. Let's see how this is done, using an SN7400 integrated circuit (Fig. 1) as our source of NAND gates. There are four 2-input NAND gates in a single

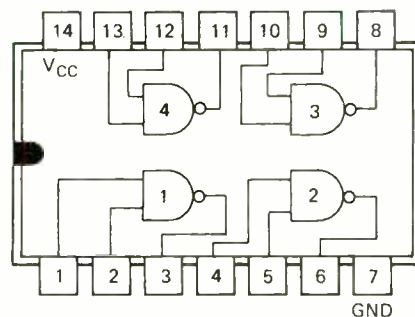

FIG. 1—IC SN7400

SN7400. Plug this IC into the test socket of your *Digi-Dyna-Check*, making certain that pin 1 of the IC is in pin 1 of the socket. (There should be two unused socket positions). The internal connections for an SN7400 are in Fig. 1. The gates have been numbered for ease in referring to them later on. Provide power to the IC by moving the matrix sliders corresponding to pins 7 and 14 down to positions 1 (GND.) and 2 (+5V), respectively.

NOT gate

A NOT gate, or INVERTER (Fig. 2)

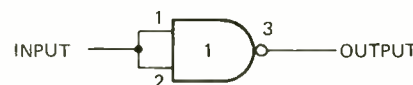

FIG. 2—NOT GATE (INVERTER)

can be made by merely tying the two inputs of a NAND gate together for use as a single input. The output will then always be in the opposite logic state to that of the input.

If you'd like to synthesize a NOT gate for use in an external circuit, move the matrix sliders corresponding to pins 1 and 2 to position 7, and the slider for pin 3 to position 8. (See Fig. 2.) The input to your inverter is now at binding post A and its output is at binding post B. The lamps corresponding to the input and output pins will indicate the logic levels at all times.

AND gate

An AND gate (Fig. 3) may be a NAND gate followed by an INVERTER.

Connect the output of NAND gate 1 to both inputs of NAND gate 2 by moving the matrix sliders for IC pins 3, 4, and 5 to position 7 (thereby using this matrix position as a jumper, or patch wire).

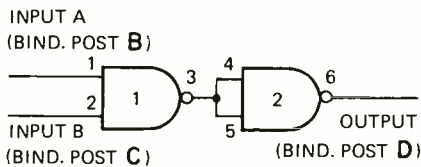

FIG. 3—AND GATE

Matrix sliders for IC pins 1 and 2 can now be set for each of the four input combinations shown in the *truth table* while observing the resultant output levels at the lamp corresponding to pin No. 6.

To make external connections to the AND gate, move the inputs (sliders for pins 1 and 2) to positions 8 and 9, and the output (slider for pin 6) to position 10. This brings the two inputs and the output out to binding posts. Remember that here too, even when external connections are involved, the lamps will still indicate logic levels at their locations in the circuit.

OR gate

Three NAND gates and two jumpers are required to build an OR gate. (Fig. 4).

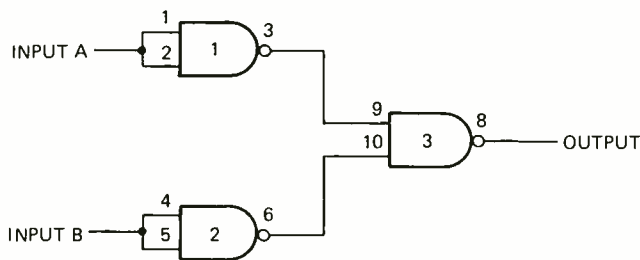

FIG. 4—OR GATE

IC pins 3 and 9 are patched together by moving their matrix sliders to position 7; put sliders for pins 6 and 10 at position 8 to connect these pins. Now, set up the input combinations given in the *truth table*, using the sliders for pins 1 and 2 as input A, sliders for pins 4 and 5 for input B. The lamp corresponding to pin 8 will then always indicate the output level for your OR gate.

NOR gate

The OR gate that we discussed above can be converted to a NOR gate (Fig. 5) by adding an inverter to its output. Set up an OR gate as above, and then move the sliders for pins 8, 12, and 13 to position 9. Enter input conditions

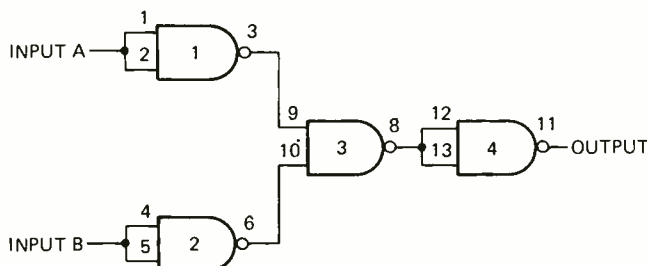

FIG. 5—NOR GATE

as before (for the OR gate), but monitor the output with the lamp corresponding to pin 11.

Memory circuits

Gates do not have memories; the output of a gate at any given time depends only on the status of its inputs *at that time!* The output of a bistable circuit, on the other hand, depends on both the *present* and *previous* input states, as we have already seen in our discussion of the J-K flip-flop in the second article in this series.

R-S flip-flop

The most basic bistable element, or circuit, is called an R-S flip-flop. It can be assembled with two NAND gates wired as shown in Fig. 6, using the same SN7400 integrated circuit that we used to build the basic gate circuits.

This circuit is used in your Digi-Dyna-Check as a contact "bounce" eliminator for the STEP switch. A momentary 1 to 0 input pulse entered alternately at the SET and RESET inputs will cause the R-S flip-flop to switch back

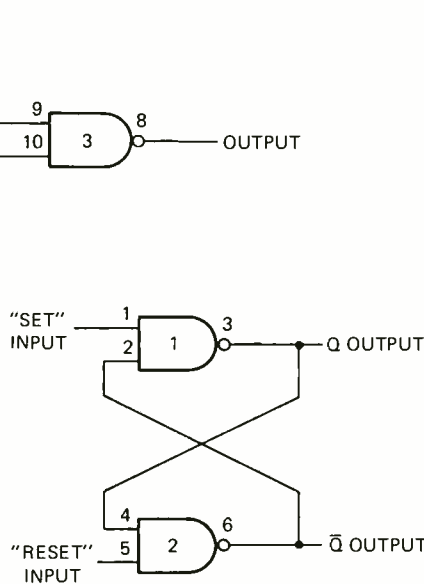

FIG. 6—R-S FLIP-FLOP

and forth, from one output state to the other, and back again.

Move the matrix sliders for pins 2 and 6 to position 7; move sliders for pins 3 and 4 to position 8. This provides the "cross" jumpers shown in the

schematic. Enter a 1 to 0 pulse at one of the inputs, then at the other, either by moving its corresponding slider from position 2 (logic 1) to position 1 (logic 0), or by using matrix position 4 in conjunction with STEP button. The Q and \bar{Q} (not-Q) output states can then be observed at lamps corresponding to their IC pins. Notice that a given input will produce a change in the output conditions only if the outputs are in specific states prior to entering the input pulse.

R-S-T flip-flop (gated memory)

Let's add a gated input to our memory circuit (R-S flip-flop) so that it will respond to input pulses only during a specific interval of time. We can do that by adding two NAND gates to our basic R-S flip-flop. See Fig. 7. Make the following connections:

Set Sliders For Pins	to Position	Remarks
2 and 6	7	Jumper
3 and 4	8	Jumper
1 and 8	9	Jumper
5 and 11	10	Jumper
10 and 12	3	Connects the STEP button to the CLOCK input.

Enter the SET and RESET input combinations shown below, using the matrix sliders for pins 9 and 13, with positions 1 (logic 0) and 2 (logic 1), and observe the resultant output states after a clock pulse is entered.

Inputs at time, n (before clock pulse)	Output, Q, at time n + 1 (after clock pulse)
Reset Set	
0 0	Q_n (No change)
0 1	1
1 0	0
1 1	Indeterminate

We see, here, that the output state changes only when the clock input *first* goes from 0 to 1, and *not* when the input information (reset and set) changes.

A wave shaping circuit

A novel application for an R-S *latching memory* is in converting various wave shapes to rectangular waves having very fast rise and fall times suitable for triggering digital devices such as counters, flip-flops, shift registers, etc. The input signal amplitude must be such that its maximum and minimum voltage levels are above and below the threshold level for triggering the shaping circuit; this is around 1 volt in this case.

A single NAND gate must be added to the basic R-S flip-flop, connected as an input inverter. This is done to ensure that the R and S signal inputs are always complementary, i.e., in opposite logic states.

Breadboard the wave shaper as fol-

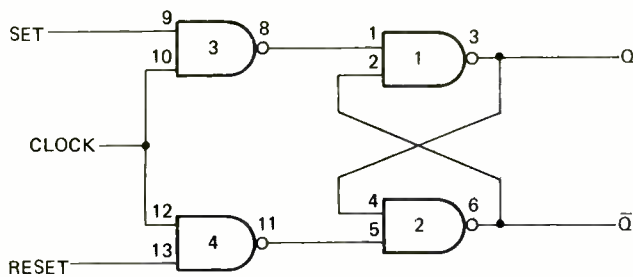

FIG. 7—R-S-T FLIP-FLOP (Gated Memory)

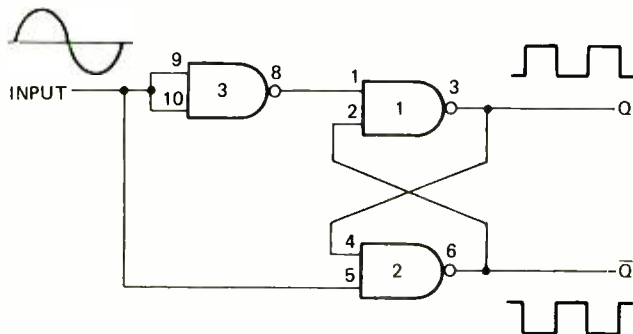

FIG. 8—WAVE-SHAPING CIRCUIT

lows using the Digi-Dyna-Check:

Set Sliders For Pins	to Position	Remarks
2 and 6	7	Jumper and Q output
3 and 4	8	Jumper and Q output
1 and 8	9	Jumper
5, 9, and 10	10	Jumper and input

Connect a sine-wave generator with an output of about 3 volts peak-to-peak to the input (binding post D) and observe the complementary rectangular waves produced at the outputs (binding posts A and B). Many other input wave shapes will also work with this circuit.

Counters, shift registers, dividers

These more complex digital circuits generally consist of multiple flip-flops connected together in various configurations to perform specialized numerical manipulations. We can use our Digi-Dyna-Check to breadboard a couple of these and see how they operate:

Four-stage binary counter. A single flip-flop has two stable states, and thus is able to "count" to two. Two flip-flops connected in series with the output of the first connected to the input of the second will count to 2×2 , or 4; three flip-flops will count to 8, and four of them will count to 16 (in binary notation, of course). Plug an SN7493 integrated circuit into the test socket, making sure that pin 1 of the IC is in pin 1 of the socket. Since this is a 14-pin IC, two socket pins will remain unused. The SN7493 (Fig. 9) contains four flip-flops, three of which are internally connected together as a three-stage binary counter. The fourth flip-flop can either be used alone or together with the others to form a four-stage binary counter,

capable of assuming 16 stable states (counting to 16).

We'll set up the four-stage version:

Set sliders for pins	to Position	Remarks
10	1	Ground
5	2	+5V (V_{cc})
12 and 1	7	Jumper
14	3	STEP button, to input pulses to be counted to clear the counter, and
2 and 3	2, then to 1 then set	it up for counting.

Now, input count pulses by pressing and releasing the STEP button once for each count and observe the lamps for the outputs of flip-flops A, B, C, and D at lamps 12, 9, 8, and 11, respectively. They should change, with each input count, according to the following *truth table*:

Count	Outputs: Lamps:	A 12	B 9	C 8	D 11
0		0	0	0	0
1		0	0	0	0
2		0	1	0	0
3		1	1	0	0
4		0	0	1	0
5		1	0	1	0
6		0	1	1	0
7		1	1	1	0
8		0	0	0	1
9		1	0	0	1
10		0	1	0	1
11		1	1	0	1
12		0	0	1	1
13		1	0	1	1
14		0	1	1	1
15		1	1	1	1
16 (or 0)		0	0	0	0
		etc.			

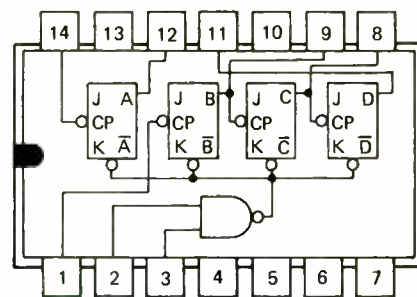

FIG. 9—PROGRAMMABLE DIVIDER

The counter can be reset to zero and made ready for starting the count again, at any time during its counting cycle, by moving the sliders for pins 2 and 3 (reset inputs) to position 2 (logic 1) and then back to position 1 (logic 0). Of course, here again, if you want to count pulses from an external source, you can move the slider for pin 14 to position 8, thereby connecting the counter input to binding post B. The external signal can now be entered at this binding post.

A programmable divider. A DM8520 integrated circuit is used in this experiment (Fig. 10). It contains

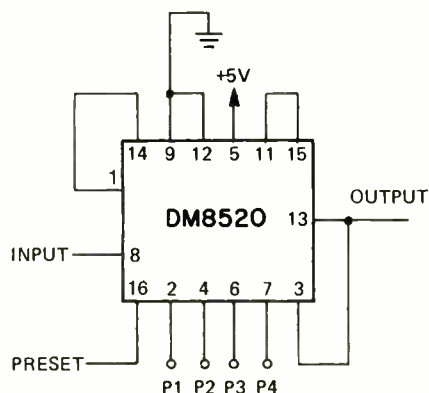

FIG. 10—PROGRAMMABLE DIVIDER

four flip-flops, internally wired together to form a 4-bit shift register. In addition to the count input and output, there are four parallel "programming" inputs and a "preset" input that can be used to preset the register to divide by any number from 2 to 15. Thus, for example, if the register is programmed to divide by ten, a single output pulse will be produced for every ten input pulses entered.

Plug a DM8520 IC into the test socket and make the necessary connections:

Set sliders for pins	to Position	Remarks
9 and 12	1	Ground
5	2	+5V (V_{cc})
11 and 15	7	Jumper
1 and 14	8	Jumper
3 and 13	9	Jumper, and output at binding post C
8	10	Input at binding post D

(continued on page 94)

R-E's Service Clinic

solid state "tubes"

*Plug-in direct
replacements for
vacuum-tube diodes*

by JACK DARR
SERVICE EDITOR

ONE OF THE FIRST THINGS THEY SAID about semiconductor devices was "They will replace vacuum tubes!" They haven't quite made it yet, but they're working on it. In fact, the only place where you can make a one-for-one direct substitution is in the rectifier socket (sic). Let's look at a few of these.

Plug-in direct-replacements for the old standard full-wave rectifiers have been available for quite a while. They started with the 5U4, etc. Now, you can get them to replace practically every rectifier tube, from the old faithful '80 up to 866's and 872A's; transmitting-type rectifiers capable of carrying current up to 1.25 and 1.75 amperes, at working voltages up in the thousands.

When making this type of substitution you may have to add a small series resistance. It compensates for the lower voltage drop across the solid-state rectifier. Without it, your dc voltage may run high enough to exceed the working voltage rating of the filter capacitors.

The next one that came along was a solid-state substitute for the focus rectifier tube, in color TV sets. The type R-2AV2 solid-state focus rectifier is a plug-in replacement for the original 1V2 and 2AV2 rectifiers in the receiver.

Up until now, it has been common practice to make high-voltage rectifiers by stacking individual solid-state diode "chips" or discs in series, to get the high piv rating needed to withstand high surge voltages. Variations in distributed capacitance, voltage breakdown, and switching-time between individual diodes have caused uneven distribution of the voltage drops, and eventual breakdown. This was quite a problem in the first focus rectifiers. However, since this is a dry circuit (practically no current at all), it wasn't too hard to overcome.

The high-voltage rectifier in color TV posed a problem, for the reasons just given. The very high peak voltage, up to 35,000 volts, and the fast rise-time of this pulse (from nothing up to 35 kV in about 7 μ s) made it difficult to keep everything lined up! About 1968, Motorola came up with a successful HV rectifier. They called it the "SSHVR" (Solid-State HV Rectifier). They wanted it to get rid of the last chassis tube in the

Quasar series. This is the only one of the whole group that isn't really a plug-in replacement for tubes like 3A3, etc.

To get the best performance out of this new rectifier, a new flyback transformer should be used. It must have more parasitic stray capacitance to match the lower capacitance of the SSHVR. The socket isn't compatible; the SSHVR has only a plate-cap type connector on each end, which is all it needs. Improvements in device *matching*, together with a great improvement in corona-proof packaging and encapsulation, made this unit possible.

The EDI R-3A3, R-3AT2 and R-3DB3 Solid-Tubes are direct plug-in replacements for vacuum-tube rectifiers and, are ideal in cases where the rectifier filament winding may be defective.

Chronologically, the next tube to be replaced was the damper. Electronic Devices, Inc. has just announced another direct plug-in substitute. The R-DW4 Solid Tube is designed as a direct replacement for 6DW4, 6CK3, 6CL3 and 6BA3 tubes, in color-TV circuitry. Because of the very high pulse voltages in this circuit, it was pretty difficult to work out a practical replacement for the vacuum tube here, but with improvements in technology and fabrication techniques, they made it.

The latest thing in color TV circuitry, introduced in several 1971 sets, is the solid-state voltage multiplier unit. RCA, Magnovox, Sears, Sylvania, Zenith and others are using them. They're made in different configurations. RCA uses a voltage-quadrupler, and most of the others use voltage-triplers. The basic circuit-action is similar to the well-known voltage-doubler, which has been around for a long time. The first time I ran into it was in an old b-w DuMont, back in the 1950's! (I still remember opening up the HV cage and wondering what the heck they were doing with two 1B3's!)

Voltage-multiplication in the HV stage has several advantages. For one, the flyback transformer does not need that great big HV winding! Not nearly so big as before, anyhow. For example, to get 24 kV with a voltage-quadrupler, the flyback pulse can be only 6 or 7 kV instead of 30-35 kV. This reduces, if not

This column is for your service problems—TV, radio, audio or general and industrial electronics. We answer all questions individually by mail, free of charge, and the more interesting ones will be printed here.

If you're really stuck, write us. We'll do our best to help you. Don't forget to enclose a stamped, self-addressed envelope. Write: Service Editor, Radio-Electronics, 200 Park Ave. South, New York 10003.

eliminates entirely, any chance of X-ray radiation from the HV rectifier, since you have to get up above 20 kV before you find any perceptible X-radiation.

There is another nice little fringe benefit. On most of the multiplier assemblies, you can tap off the focus voltage, after the first stage. There goes the separate focus rectifier. In addition, the focus voltage will automatically remain right where it must be—a fixed percentage of the applied HV. About 20% is average.

For typical service work, you can always replace a tube-type B+ rectifier such as a 5U4 with a pair of silicon diodes. Just pull the old tube, and tack two of the little 1.0 ampere 1,000 pV diodes to the plate and cathode terminals of the socket. (It is highly advisable to connect these right-end-to. Otherwise, it can be embarrassing. If you're using some of the bead type silicon diodes, get out the magnifying glass, and look for the band marking the cathode end. Otherwise, pop goes the fuse.)

Afterward, be sure to check the surge voltage. Connect the dc voltmeter to the input filter capacitor, turn the power on, and read the surge voltage. You will normally get a higher voltage than before. If the surge goes above the safe rating of the filter capacitors, you'd better add a small surge resistor, either between the rectifier output and the input filter, or between the ac supply and the rectifier anode.

In some cases, the extra 20-40 volts of B+ will be a big help. In some of the older sets, this may even help you to get that last ¼ inch of width that you need!

(Addenda: International Rectifier and EDI make exact-replacements for the voltage-multiplier units used in RCA, Zenith, Sylvania, Magnavox, Sears, etc.)

R-E

Reader Questions

FACTORY GOOF?

In a Sears 528.71270 chassis, the 17BF11 tube plate got red hot. I had replaced the tube either 3 or 4 times previously. Checking through the circuit, I found the plate voltage more than double that shown on the schematic! 275 volts instead of 125.

On the chassis, I found the +275V and +125V points wired together! This is the second set of this model that I have found in this condition. Is this a modification, or what?—R.M., Marblehead, Mass.

Looks more like a plain old factory goof to me! If you have found two with an identical miswiring, there could be more. Since the -BF11 series of tubes have a maximum plate-voltage rating of

150 volts, it isn't likely that it was designed with +275V on it. Thanks for sending this in, to warn others to keep an eye out for it.

LOW CURRENT, FULL RASTER

I've been doing some checking on a Zenith 25MC33, and got some odd results. The cathode current of the 6JS6 is only 140 mA, and adjusting the horizontal efficiency coil will bring it up to only 150 mA.

I have 24.5 kV on the HV, and the raster is full-width. Focus good, picture OK. I don't understand this. What should I check now?—V.S., Mattoon, Ill.

The first thing I'd check would be my dc milliammeter! Notice this; every one of your "normal outputs" from that stage is perfect! You have the right HV, sweep, focus, boost, etc. So, the stage IS working normally, and delivering the right amount of power. If it is doing

this, then it IS drawing somewhere around 200 mA through the 6JS6.

(Note: look around under that tube-socket. Every once in a while you'll find an extra ground connection, or shunt-path, that will foul up the meter-reading!)

"PULSING" FOCUS

I have a very peculiar problem with a Zenith 25MC33 color chassis. The thing "pulses" in and out of focus at a rate of about 2 or 3 seconds. The funny thing is that the focus voltage, read at the focus rectifier, does not go up and down as you'd expect it to!

I wiggled the damper tube, and it cleared up momentarily; so I cleaned the damper socket contacts. Now it's back again!—C.H., Port Angeles, Ca.

From your description of the symptoms and from some similar experience (continued on page 68)

CHANNELLOCK

Gives You More In Hand Tools Including

STANDARD "SPECIALS" (at standard prices)

Every one of these special purpose tools is a standard item in the CHANNELLOCK line, at standard price.

Why show these "specials"? To tell you that you can get CHANNELLOCK quality in a wide range of both standard and special purpose pliers.

GET THE WHOLE STORY in our three-color catalog. Yours for the asking.



ELECTRICIANS' WIRING PLIER. Patented notches strip insulation from 14 and 12 gauge wire slick as a whistle.



WIREMASTER PLIER. High leverage design provides 40% more cutting power than standard design wire cutting pliers.



CURVED LONG NOSE PLIER. Goes 'round the corner to get to work.



PLASTIC CUTTING DIAGONAL. Flush-trims molded plastic sprues clean, fast.



SHORT NOSE SHEARING PLIER. High leverage design for easy cutting of channel iron flanges.



CURVED DIAGONAL CUTTER. Jim-dandy for pulling cotter pins.

TOOLS BY
CHAN NEL LOCK

MEADVILLE, PA. 16335

Circle 12 on reader service card

JULY 1972 • RADIO-ELECTRONICS 63

The Way to Get Ahead in Electronics is To Get More Knowledge Into Your Head And a Grantham Degree Into Your Pocket!

The above headline makes a point that affects more than your head and pocket. It can affect your *pocket-book* too. Getting ahead in the pocketbook is of great interest to most of us, and the Grantham ASEE Degree program not only helps you get *ahead* in the pocketbook but also puts a better one on your shoulders. As an electronics technician, you can really get ahead by getting more education, and if you don't need a degree in your pocket why not hang it on the wall!

Maybe we don't write the best ads, but we really know how to teach electronics and related subjects

by correspondence. We have been doing it for more than twenty years.

New Grantham Program for Beginners

Until recently we accepted only experienced electronics technicians in our degree program. However, we have now added a new program for beginners and those with very limited experience. The two different programs are described in different catalogs. In your inquiry, be sure to indicate the true level of your experience, so we can send the catalog that fits your particular situation.

Advance beyond the technician level. Become an engineer. If you are a high school graduate and have a good aptitude for electronics and mathematics, you can earn the Degree of Associate in Science in Electronics Engineering mainly by

STUDYING AT HOME

Investigate *now* the Grantham college-level program in electronics engineering, offered (by correspondence) to working technicians while they remain on their jobs. Grantham lessons place heavy stress on fundamental concepts of logic and mathematics (taught so you can understand them), and build from there in a systematic manner, covering physics, circuits, and systems. The lessons are easy to understand because they are carefully written, with step-by-step explanations and consistent review and regrouping of ideas.

Now is the time, not only to protect yourself from unemployment, but also *to prepare yourself for the greater demand in engineering* which is sure to come. You can't become an engineer in a few short weeks; it takes many months. You can be upgrading yourself in your present job while the economy is "slow", and then *be ready to move into engineering* when the national economy gets going again. Yes, now is the time to prepare, so that *you* will be ready to take advantage of opportunity when it presents itself.

STEP UP!

MOVE AHEAD

The Way to Get Ahead in Electronics is To Get More Knowledge Into Your Head And a Grantham Degree Into Your Pocket!



When the Degree of Associate in Science in Electronics Engineering is conferred upon you, it will be because you've *earned* it. You'll have a knowledge and understanding of electronics that won't fail you. You'll know *what* you're doing, and *why* you're doing it. And what's more — your associates will know that you know what you're doing. You'll be proud to say that you're a GRANTHAM man. The pride that the School takes in its graduates is reflected in this simple statement: GRANTHAM graduates are men who have learned to step up!

F.C.C. COMMERCIAL OPERATOR LICENSE

Training

is part of the Grantham

ASSOCIATE DEGREE program IN ELECTRONICS for beginners

In today's world of electronics employment, an FCC license is important — sometimes essential — but it's not enough! Without further education, you can't make it to the top. Get your FCC License without fail, but don't stop there. To prepare for the best jobs, continue your electronics education and get your Associate Degree in Electronics.

This is good common sense for those who want to make more money in electronics. It also makes sense to prepare for your FCC license with the School that gives degree credit for your license training — and with the School that can then take you from the FCC license level to the Degree level.

If you are a beginner in electronics you will need laboratory training. Our special program for beginners includes correspondence laboratory lessons and real laboratory equipment.

This booklet **FREE!**

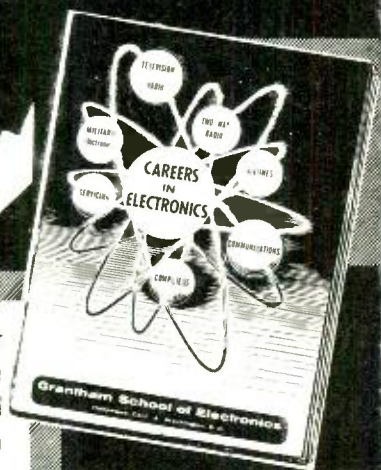

This free booklet explains what an FCC license and ASEE degree can do for your future.

Grantham School of Engineering is a college-level correspondence institution, specializing in electronics, authorized under the laws of the State of California to grant academic degrees.

The School is approved under the G.I. Bill, is accredited by the Accrediting Commission of the National Home Study Council, and is an eligible institution under the Federally Insured Student Loan Program.

Grantham offers two different programs for an associate degree in electronics—one program for beginners which includes FCC license preparation and laboratory lessons & equipment, and another program for experienced technicians which does not include FCC license preparation or laboratory lessons.



GRANTHAM SCHOOL OF ENGINEERING



ATTENTION, WASHINGTON D.C. AREA

Grantham School of Engineering operates a *resident* technical institute in Falls Church, Va. If you are interested in attending resident classes to earn your FCC license and prepare for a good job as an electronics technician, ask for our free GEI Bulletin. Write, phone, or visit:

GRANTHAM ELECTRONICS INSTITUTE

5884 Leesburg Pike
Falls Church, Virginia 22041
Telephone: (703) 820-4417

Grantham School of Engineering RE-7-72
1505 N. Western Ave., Hollywood, Cal. 90027

Please send me your free Bulletin which explains how the Grantham educational program can prepare me for a *degree* in electronics.

- I am a beginner in electronics.
- I have a little experience with electronic equipment.
- I am an experienced electronics technician.

Name _____

Address _____

City _____ State _____ Zip _____

**Dreaming
about a pair
of \$300
condenser
microphones?**

**Think
seriously
about these:
\$39.75* each!**



Model 1710 Electret Condenser Omnidirectional Microphone

All of the great condenser advantages are here without compromise. Flat, extended range, excellent transient response, high output, low noise, and ultra-clean sound. But the new E-V electret condenser microphones need no high voltage power supply. Just an AA penlite battery to operate the built-in FET impedance converter. The result is studio performance without complications and at a dramatically lower price.

There are 4 new E-V electret microphones, including cardioid models, from \$39.75 to just \$75.00, audiophile net. Second-generation designs with unusually high resistance to heat and humidity. Hear them today at your nearby Electro-Voice soundroom. Or write for details.

More U.S. recording studios use Electro-Voice microphones than any other brand.

*Suggested retail price. Microphones shown on Model 121 Desk Stand, \$17.00 each.

Electro-Voice®

ELECTRO-VOICE, INC., Dept. 722E
613 Cecil Street, Buchanan, Michigan 49107
In Europe: Electro-Voice, S. A., Römerstrasse 49,
2560 Nidau, Switzerland

a **Gulton**
COMPANY

Circle 13 on reader service card

READER QUESTIONS

(continued from page 63)

periences on other makes, I have a suspicion. Take the pix-tube socket off the tube and look at focus pin No. 9. Then check the No. 9 hole in the socket. If it is filled with a greenish powder or there are traces of it on the focus pin, look out!

Bare metal, charged with a very high voltage, and exposed to the air, will often "corrode". It is some kind of oxidation, and I don't understand the exact chemical reaction, but I'll guarantee that it will happen! (Used to eat wires in two in old radio af output transformers; i.f.'s etc.)

So take the socket apart. You are likely to find the focus pin contact eaten away or broken. The high voltage will "jump" the gap through the oxide, developing a varying resistance making the focus change. Best cure is to replace the socket, although you can often take a contact from a small wafer-type, 7- or 9-pin tube socket and make one.

RIPPLE IN LINES, TOP AND BOTTOM

In a Heathkit GR-25 color TV, C704 shorted, burned up and almost disintegrated. I replaced both it and C705, with 500-pF capacitors. Now I have a peculiar rippling in horizontal lines at the top and bottom of the raster—about five or six wiggles all the way across. Lines in the middle of the screen straight. —L.H., Reston, Va.

Let's polish up the crystal ball and have a look! It is quite likely, from your description, that the heart of the trouble is in the pincushion-corrector circuitry, since these have the maximum effect at the top and bottom of the screen. When C704 (not shown) shorted in the boost circuit it could have blown something in the pin-corrector circuit (below).

Possibilities: Diode D801; pin cushion-corrector transformer T803, control R810; or caused by the high spike voltage that was undoubtedly fed into this circuit, some of the bypass and shaping capacitors—C803, C802, etc.

As in most color sets, there is a horizontal-frequency spike waveform used for blanking. It has quite a good bit of ripple along the baseline. If something is upset in the circuit and this baseline ripple is allowed to get into places where it shouldn't, it causes trouble. Suggestion: try the pincushion corrector adjustments, and see if they work normally. If they don't, then check this circuit for other damaged parts.

PURITY PROBLEM

After changing the picture tube in a Motorola TS-914 chassis, I ran into an odd purity problem. We could adjust it for an all-red raster, turn it off, and when it was turned on again it wasn't red any more. Readjusting things didn't help! What gives?—H.S., Vincennes, Ind.

Check the degaussing switch. It sounds very much as if the tube is being "re-gaussed" instead of degaussed. This model used a thermal switch: if the contacts arc and weld shut, the degaussing

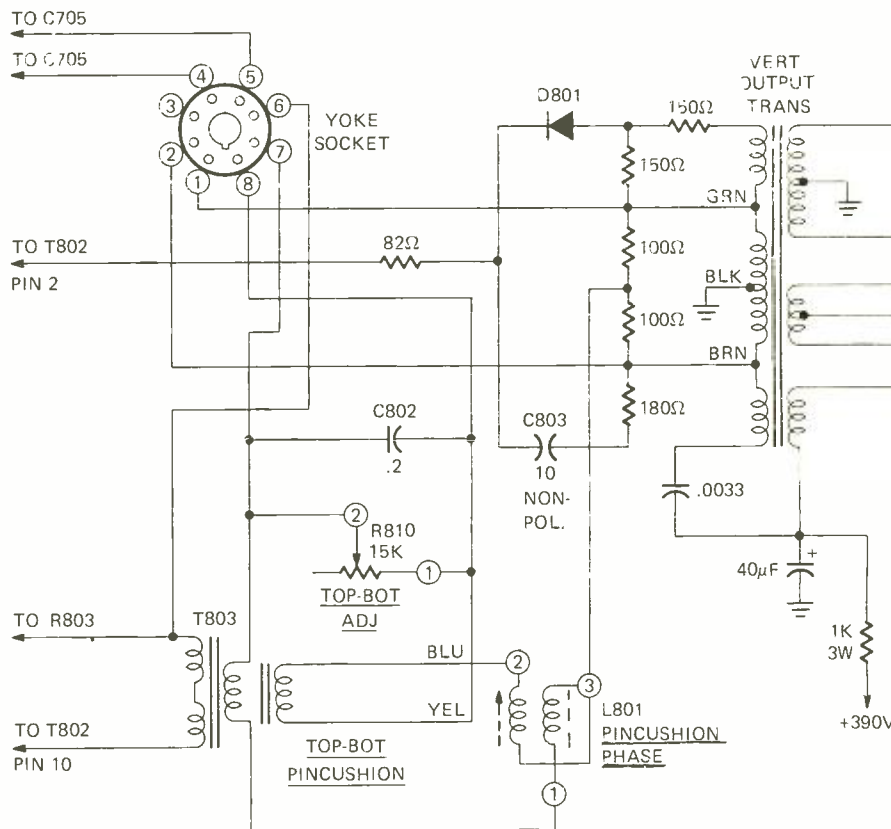

coil stays in the circuit and actually remagnetizes the tube.

Check; degauss it with a regular coil, then turn it on and off several times, letting it cool between times. If the purity gets steadily worse, check that switch. Replacement is the best cure.

FALSE KEYSTONE

I have a pretty distinct keystone raster problem in a Zenith 20Y1C50 color chassis. Still, I've changed the yoke, with no results! I thought that bad yokes were the only thing that caused keystoneing!—P.S., Chicago, Ill.

In Zenith rectangular-tube chasses, with pincushion correction, there is a

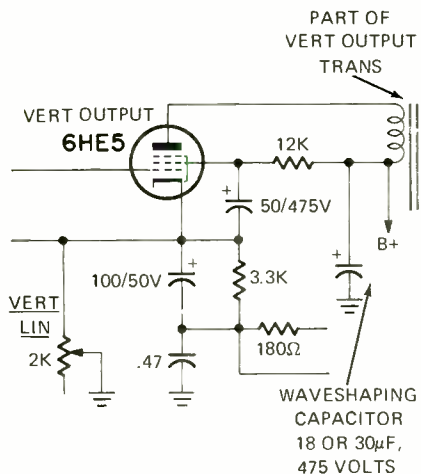

waveshaping capacitor in the screen-grid circuit of the vertical output tube. It is actually a part of the pin-corrector circuit. If it opens, you'll get a false keystone symptom, with the raster wider at the top than the bottom, by about 1.0 to 1.5 inch. It may be an 18 or 30- μ F capacitor, depending on the chassis number.

POWER TRANSFORMER

I need a replacement power transformer for a Knight-Kit KG-630 oscilloscope. Can't find anything on it.—R.W., Schenectady, N.Y.

I believe that a Thordarson-Meissner 22R121 will work nicely in this instrument. It's not exactly the same size, but you should be able to mount it without too much trouble. Electrical specs are almost identical.

You can replace that original 6X4 rectifier with a pair of silicon diodes, and save that much heater current. This will also give you a bit more dc voltage output. This transformer has a 2.5 volt winding; this would be too much for the original 1V2 HV rectifier; try a stock color-TV focus rectifier in its place! Should work nicely.

AMPLITUDE-MODULATED MARKERS

I hear about sweep-generators with modulated markers for setting traps. Can I do this with my Heathkit IG-14? Also;

while aligning a CTC-7 RCA, I applied the negative bias to "Test point A" and lost my curve.—A.Z., Columbus, Ohio

Yes. For example, to get an AM modulated marker for the 41.25-MHz traps, punch the 41.25-MHz marker button, and the MOD button at the same time. Feed the signal for the MARKER output into the i.f. input, or tuner test point. Scope to the video detector, through the post-marker averter.

You'll see the 400-Hz modulation on the scope. Turn up the generator gain until you get a fair-sized pattern. Now, just tune the trap for minimum amplitude of the sinewave, and that's it. This can be done with any sweep-gener-

ator having AM modulation of the markers.

You've just got *too much* negative bias, if you lose the curve. Reduce this until you can see it again.

RASTER INCREASES IN SIZE

I've got a weird problem. On this little RCA KCS-153 transistor TV. The raster gradually increases in size, vertically, as the set warms up. Takes about 30 to 40 minutes, and increases about 1.5 inches. Changed the output transistor several times; no luck.

Only change I notice is that the collector voltage of the vertical output transistor rises from +3.1 to +4.2 volts as

RCA CONSUMER ELECTRONICS SERVICE DATA SUBSCRIPTIONS



A SUBSCRIPTION INCLUDES A COMPLETE "FILE" YEAR OF:

- COLOR TELEVISION DATA
- B & W TELEVISION DATA
- RADIO DATA
- PHONOGRAPH DATA
- TAPE RECORDER DATA
- "GOLDENROD" BULLETINS
- PARTS TIPS
- SERVICE TIPS
- "PLAIN TALK" PERIODICALS
- COMPLETE INDEX

- "File-1972" Service Data including 2 binders \$19.95
- "File-1972" Service Data subscription \$14.95 (Binders available separately—\$2.95 each)
- Previous years Data (\$12.50 per set) File: 71 , 70 , 69 , 68

Amount enclosed: \$

NAME (Please Print)

STREET ADDRESS

CITY

STATE

ZIP CODE

- Your order will be processed promptly upon receipt of your check or money order in the amount indicated above

SEND TO: RCA CONSUMER ELECTRONICS

600 N. Sherman Drive, Indianapolis, Ind. 46201

ATTN: Technical Publications, 8-106 (Or Contact Your Distributor)

Note: Prices Subject To Change Without Notice

Postpaid U.S.A. only

Circle 14 on reader service card

versatile new 14-Piece, 1/4" Sq. Drive socket wrench set drives fasteners 7 different ways



REVERSIBLE RATCHET — Precision made, long life, fully enclosed mechanism. Short handle swing for close quarter work.

UNIQUE SPINNER/EXTENSION — 5-3/4" overall. Plastic (UL) handle with 1/4" sq. drive socket insert for ratchet. Use also as regular nutdriver.

2" DRIVE EXTENSION — Fits on ratchet or either end of spinner/extension.

RUGGED, HEAT TREATED, ALLOY STEEL SOCKETS — Nine for hex sizes 3/16" thru 1/2". Two dual purpose for hex and square sizes 1/4" and 5/16".

FREE STICK-ON INITIALS personalize the sturdy plastic case and help prevent loss or mix-up.



No. 1001 SET

Made in U.S.A.

nationwide availability through local distributors

REQUEST BULLETIN N770



XCELITE, INC., 10 Bank St., Orchard Park, N. Y. 14127

In Canada contact Charles W. Pointon, Ltd.

Circle 15 on reader service card

the height increases. I'm "frozen" on this; can you help?—R.W., Rochester, N.Y.

There's one obvious thing here; the vertical output transistor is conducting more as it warms up. However, since you have replaced it, this is not a simple thermal runaway, which is usually due to insufficient heat-sinking, or leakage. So, it looks as if the root of the problem is not in the output stage alone.

There are four direct-coupled transistors in this vertical stage. Any one of these could be either thermal or leaky. This would change the bias on the output stage and cause it to conduct too heavily.

So go back through there. Try spraying coolant on each of the drivers and oscillator, and see if it has any effect. If not, take them out and check them for leakage. You can check for thermal leakage, with the transistor on the tester, by warming it up with the tip of a soldering iron. See if the leakage reading goes up too much with heat. Then spray it with coolant.

HV RECTIFIER FAILURES

In a Zenith 20Y1C50 color chassis, the HV rectifier fails frequently, and sometimes the fuse blows. I'm reading 33 kV on the HV at minimum brightness, and 30 kV at maximum. I suspect the HV regulator. Changed all tubes, no help. I've got +420 volts on the 6HS5 grid, 460 volts on the cathode, and a 300- μ A current.—G.F., Lafayette, Ind.

Your HV rectifier is being overloaded. When it fails it can blow a fuse. I've seen them short and blow not only a fuse, but the horizontal output tube too!

You are not drawing enough current in the HV regulator. Your HV should be not more than 25 kV at minimum brightness. Normal voltages for this tube are grid, +335 volts, cathode, +365 v. and a current of 600- μ A. This accounts for your high HV.

Check all of the capacitors and resistors around the 6HS5 HV regulator.

Your cathode is suspiciously high, since there is only a 220-ohm resistor between it and the +390 volt source. Check that VDR between the 870 volt boost source and the top of the HV adjust control, and the 1.6-megohm resistor from the bottom of the control to ground. Also, check the 68-pF pulse-coupling capacitor from the flyback to the 6HS5 grid; this is important.

VENETIAN BLIND INTERFERENCE

I've got an odd problem on a 14A9C50 Zenith color TV. On nearly all stations, there are horizontal black lines over the whole screen, top to bottom. Looks a lot like venetian blind interference, but this is due to co-channel interference, isn't it?—L.H., Baltimore, Md.

I don't think you'd have co-channel interference on all channels. From the recesses of my service file, I dredged up a note on this chassis. If the 1- μ F bypass capacitor, on the base of the i.f. age transistor to ground, is open, you'll get this type of symptoms. This is C218 on the Zenith schematic. By the way, this is a non-polarized electrolytic, and must be replaced with the same type.

CASE OF THE MYSTERIOUS HUM-BAR

Why didn't somebody tell me these things? I got two Panasonic AN-42D TV sets. One had a 60-Hz black bar in the raster. The other had a sync problem. So I took the "easy one" first. If I can't fix a simple ripple problem in a few minutes, I shouldn't be in this business.

About two hours or so later, I was beginning to wonder. I replaced the filters, checked all of the tubes, (and even cross-checked the pix tube against the other set!) and I still have the big, fat hum-bar. I sat and looked at this electronic miracle. I said to myself, "The only thing you haven't changed is the rectifier! And, everyone knows that silicon rectifiers either work, or they're shorted or open!" So, I changed it.

Lo and behold. No hum bar. All

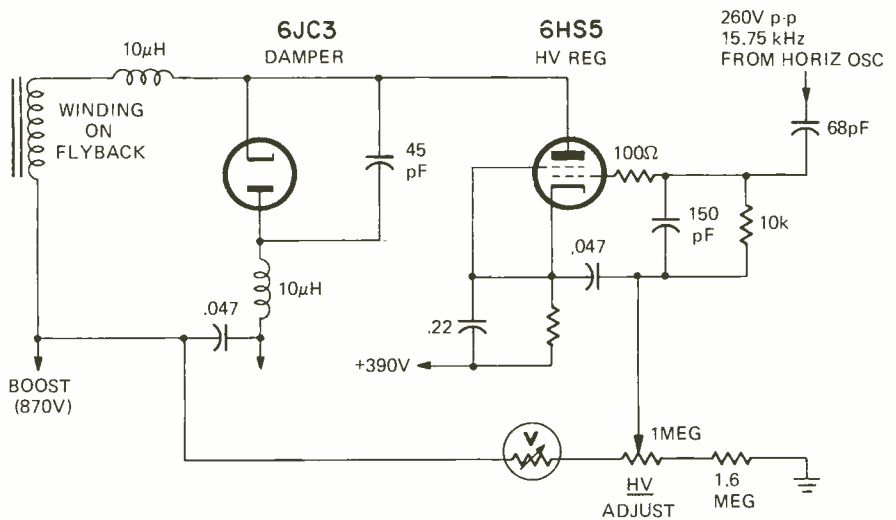

gone; worked perfectly. Now, O Genius, I've got a question for you. Why didn't you tell me that a solid-state rectifier could cause a hum-bar? Where is the article that says that, huh?—Sergei Rodionoff, CET, Woodland Hills, Calif.

Because I didn't know it, that's why. For a long time, I swore (unfortunately, in print) that silicon rectifiers had only one possible fault; they shorted. Not too long after that, I discovered one that was open. This unit is now taped up over my bench with a sign on it. Up until now, I too would have scoffed at the idea that a solid-state rectifier could cause such symptoms. Now I won't.

HIGH-VOLTAGE PROBLEMS

I am having HV troubles with a Motorola TS-914. There is only 8 kV at the pix-tube anode. Screen voltage on 6JS6 is only 60 volts, and I read 34-mA current. Supply seems OK. Cathode current reads only 100 mA. I get a -75 volts on the 6JS6 grid. I'm running this chassis out of the cabinet, with the yoke, etc disconnected. Isn't that ok?—H.B., Utica, Mich.

Nope. Not with this one. When you disconnect the horizontal yoke, you un-load the flyback, and kill the boost voltage. This could be the cause of your odd screen-grid reading. The screen is trying to carry some of what should be the plate current. Normal is only 18 mA. Also; in the TS-914, when you disconnect the auto-degaussing coil, you open the focus circuit. Loss of the focus voltage will usually black out the raster, even with normal HV.

Hook it all up, using extension cables, and recheck. -75 volts on the 6JS6 control grid is too much. Should run about a -60. More than this will bias-off the tube, and reduce the output. There is a HV control circuit in this chassis; diode fed by pulse from flyback, which regulates the bias on the 6JS6. Check this to see that it is ok.

If everything else seems to be OK, you might suspect the flyback. The HV secondary winding can be replaced in these sets, without the other windings; it's made in two sections. HV winding could have a small short while the rest is OK.

OUTPUT TRANSFORMER

I need a replacement output transformer for a 1960 Knight KF-65 stereo amplifier. One of them is open. Can't find a listing, or the schematic. Output tubes are ECL82's. Original transformer had 4, 8, 16 ohm taps. Where can I get an exact replacement?—H.B., Lansing, Mich.

All you need to know is the correct plate load impedance of the output tubes, and the impedance needed for the speakers. The ECL82 tubes are the same as the 6BM8. These have a 5,000-ohm plate load. So you order any one of

several transformers that will match these figures: 5,000 ohms primary, 4, 8, 16-ohm secondary, 20 watts

If you have a space problem, use something like the open-frame Thor-darson 24S92, for a single tube, or 24S17 for push-pull Class A. If you want the "hi-fi" type, 22S11 or 26S66. All are rated at 15 watts or better.

VIDEO SMEAR

We have a dog. It's an intermittent video smear and phase pulling on a KCS-130 RCA. We find a 60-Hz sawtooth on the agc line whenever this happens. For some reason, this stays there when the vertical oscillator is pulled. What's going

on?—C.K., Stuart, Fla.

I'd suspect insufficient bypassing on the agc line. This should present absolutely "zero impedance to ground" at all signal frequencies apt to be found; vertical, horizontal and video!

This could be due to a hairline crack in a PC board conductor, a cold solder joint or a poor ground on an agc bypass capacitor. Quick-check; scope the agc line. When the pulses appear, quickly scope the ground end of each bypass capacitor. Alternate; use a small clip-lead with a needle-point test prod on one end. Ground the clip, then touch the ground terminals of the capacitors with the needle point. R-E

TV TUNER SERVICE

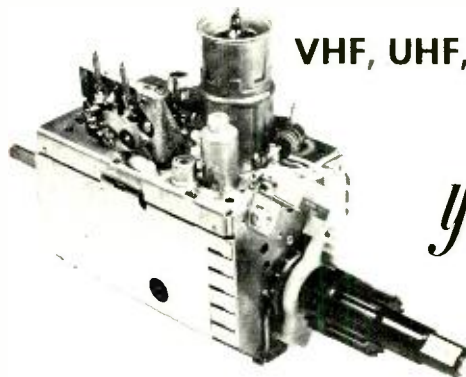

VHF, UHF, FM or IF-Subchassis. . .

. . . All Makes

you get...

Fast 8 hr. Service!

You owe it to yourself

to try P.T.S. We are the fastest growing, oldest and now the largest tuner service company in the world. Here is what you get.

1. Fastest Service—8 hr.—in and out the same day. Overnight transit to one of our six plants, for parts, tuners or IF-modules.
2. All tuners cleaned inside and out, repaired, realigned and air tested.
3. On IF-modules all stages checked, all traps set with high calibre test equipment.
4. Fine Quality! Your customers are satisfied and you are not bothered with returning your units for rework!
5. Lower Cost! Up to \$5.50 less than other tuner companies!
6. Friendly, helpful personalized service!

1 YEAR GUARANTEE



FIRST TO OFFER 365-DAY GUARANTEE!
COLOR—BLACK & WHITE—TRANSISTOR TUNERS—
ALL MAKES
GUARANTEED COLOR ALIGNMENT—
NO ADDITIONAL CHARGE

LIKE TO DO IT YOURSELF?

PTS makes all tuner parts available to you.

Send one dollar (redeemable) for our TUNER REPLACEMENT GUIDE AND PARTS CATALOG

- 60 pages of top information
- Blow-up of all tuners
- Largest exact tuner replacement guide
- Antenna Coil Replacement Guide
- Multi-fit Replacement Tuner Shaft Guide

We offer you finer, faster...

**Precision
Tuner Service**

VHF-UHF-FM \$ 9.95

UV-COMBO \$16.95

IF-MODULE \$12.50

Major Parts charged at Net Price

CUSTOMIZED REPLACEMENTS AVAILABLE FOR \$12.95 UP (NEW OR REBUILT)

For fastest service, send faulty unit with tubes, shields and all broken parts to

PTS ELECTRONICS, INC.

HOME OFFICE—
SOUTHEAST—
WEST COAST—
EAST—
SOUTHWEST—
MOUNTAIN—

P.O. Box 272—Bloomington, Ind. 47401
P.O. Box 6771—Jacksonville, Fla. 32205
P.O. Box 41354—Sacramento, Calif. 95841
P.O. Box 3189—Springfield, Mass. 01103
P.O. Box 7332—Longview, Tex. 75601
P.O. Box 4145—Denver, Colo. 80204

Tel. 812/824-9331
Tel. 904/389-9852
Tel. 916/482-6220
Tel. 413/734-2737
Tel. 214/753-4334
Tel. 303/244-2818

Circle 16 on reader service card

JULY 1972 • RADIO-ELECTRONICS 71

new products

More information on new products is available from the manufacturers of items identified by a Reader Service number. Use the Reader Service Card on page 103 and circle the numbers of the new products on which you would like further information. Detach and mail the postage-paid card.

AUTO HI-FI SPEAKER AND GRILLE, *Poly-Planar A-500*. For custom flush or surface mounting. Fits where no other speaker can: practically anywhere in car, boat or trailer—in doors and kick panels, under the dash, on rear decks or roof headlinings. Only 7/8-inch mounting depth re-



quired. Output 18 watts peak. Frequency range 60 Hz to 20 kHz. Impedance 8 ohms. 7/8 x 6 x 10 inches, black with chrome trim. \$19.95 pair. —**Magitran (Div. Era Acoustics Corp)**, 311 East Park St., Moonachie, N.J. 07074.

Circle 31 on reader service card

DUAL-CHANNEL POWER AMPLIFIER, *Crown D-150*. Power output: 75 watts rms. Distortion, 20 Hz to 20 kHz, a fraction of 1% over the entire power range. Circuits direct coupled throughout, except for input blocking capacitors. Universal load matching—any load from 4 ohms up. Output transistors protected by instantly-



neously acting electronic circuit. IC op-amp front end provides linear bandwidth and gain. Signal-to-noise ratio exceeds 110 dB at rated output. 17 x 5 1/2 x 8 3/4 inches; 24 lb. \$399; optional front panel \$30; optional walnut cabinet \$33. —**Crown International**, Box 1000, Elkhart, Ind., 46514

Circle 32 on reader service card

CCTV CAMERA, *model OD-4400*. Economy camera in a weatherproof, tamper-proof, theftproof housing operates under all climatic conditions, making it useful for watching plant perimeters, parking lots, loading docks, gates, doors, etc. as well as indoor applications. 450-line resolution,

4000-to-1 automatic light compensation and silicon transistor circuitry. Camera uses an FET video input, providing a high signal-to-noise ratio (38 dB). Can provide

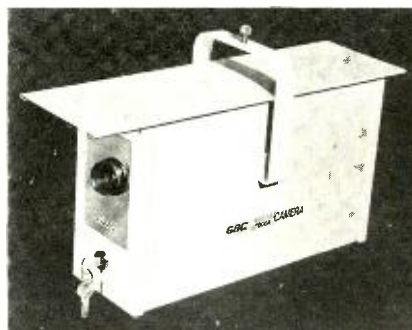

usable TV pictures with as little as two foot-candles of faceplate illumination. \$249.50. —**GBC Closed Circuit TV Corp.**, 74 Fifth Ave., New York, N.Y. 10011.

Circle 33 on reader service card

CITIZEN TWO-WAY RADIO, *Pace 100-SA*. Possibly the smallest 5-watt mobile radio ever made, measures 1 1/2 x 4 1/4 x 6 inches. Fits into any glove compartment. Full 5 watts of power with provision to transmit



on CB channel 9, plus channels 11, 12, 13 or 14 (crystals furnished). An additional channel may be selected from the 23 CB channels to provide a total of 6 channels of operation. Clip-on antenna. \$89.95. —**Pace**, Box 306, Harbor City, Calif. 90710

Circle 34 on reader service card

SHORT-WAVE PRESELECTOR, *model A-20*. An active rf amplifier that enhances weak-signal reception, improves signal-to-noise ratio and virtually eliminates images in single-conversion short-wave receivers. The model A-20 tunes from 3.9 to 22.5

MHz. It is coupled to the input of a short-wave set and one or two antennas may be connected to its input. Noise figure under 2.0 dB and gain not less than 18 dB. Gain is variable from near signal cutoff to maximum. Slow-motion calibrated dial. Passband not less than 200 kHz wide be-



tween -3 dB points. 3 1/2 x 4 x 8 inches. Operates on 117V ac (internal fusing) with transformer isolation. Toggle switches for antenna selection and (on rear panel) for PRESELECTOR IN/OUT \$49.95. —**Gilfer Associates**, P.O. Box 239, Park Ridge, N.J.

Circle 35 on reader service card

8-TRACK TAPE CARTRIDGES. These eight-track recording tape cartridges complete the line of audio recording tape products. They are available in 40-minute,



64-minute and 80-minute configurations. —**Memorex Corp.**, San Tomas at Central Express way, Santa Clara, Calif. 95052.

Circle 36 on reader service card

ULTRASONIC MOTION DETECTOR, *model UG 1000*. All receiver and transmitter heads may be connected with a

two-conductor unshielded wire. Polarity need not be maintained between units. Up to 50 transmitters and receivers may be connected. Standby power for 5 hours of emergency operation under full load of 50 transducers. Alarm sounds if the loop is cut, shunted, or a transducer removed. Sensitivity adjustment at each receiver head permits individual adjustment of each area covered. Master oscillator in the control unit acts as a transmitter,

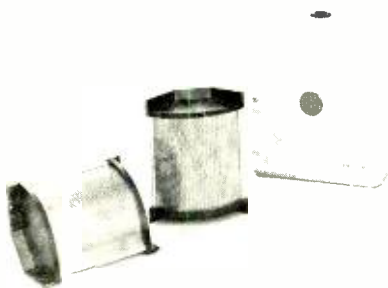

which when combined with one receiver protects the control box area; tamper protection is provided for the control unit. Alarm relay is energized during non-alarmed condition, thus providing fail-safe operation. Operates on 16 volts ac, eliminating need for conduit required by 117V units. Protects small commercial units, homes, apartments, stores or schools.—**Product Engineering Inc.**, Jackson, Miss. 39216

Circle 37 on reader service card

8-CHANNEL SCANNER, Digi Scan 4 + 4. Monitors four channels on any two out of three bands (vhf, uhf or low band) simultaneously. Features front panel scan rate control, front panel priority channel



switch, priority channel carrier delay, individual channel "lock-out," switches for programmed listening, etc.—**Unimetrics Inc.**, 23 West Mall, Plainview, N.Y. 11803

Circle 38 on reader service card

HIGH VOLTAGE RECTIFIERS, RC5477 Series. A premium version of the JEDEC 1N5477-1N5481 silicon high-voltage se-



ries, all ratings (1 ampere, 5 kV to 10 kV) of the "1N" counterpart types are matched or exceeded. Only in the single-

cycle surge rating is there a trade-off (50A peak compared to 80A peak). The RC5477 series features non-cavity, fully glassivated, controlled avalanche diodes. \$5.70 to \$8.50 each in 1-99 quantities, depending on voltage types ordered.—**Rectifier Components Corp.**, 124 Albany Ave. Freeport, N.Y. 11520.

Circle 39 on reader service card

TEST INSTRUMENT, Serviset model E-C. professional quality, suited to field or bench servicing of radio, TV, audio, appliance and allied equipment. With this instrument you can recognize and localize a defect to a particular stage of component. In 80% of the cases, you can then sub-



stitute for the defective stage or component and temporarily restore circuit operations. Performs voltage tests, 0 to 20,000 volts; signal injection tests; signal tracing tests; testing and substitution of all discrete components including transistors, diodes, etc. Comes complete with special phone, phone extension, adapter,

test leads, 30-page instruction manual, carrying pouch and battery (1.5 volt). \$29.95.—**Lee Electronic Labs**, 88 Evans St., Watertown, Mass. 02172.

Circle 40 on reader service card

DRIVER SETS, PS-6, PS-140 and PS-130. All-purpose screwdriver/nutdriver sets consisting of assortments of color-coded midget tools and a "piggyback" torque amplifier handle that enlarges gripping



surface, extends reach, and increases driving power. Drivers for slotted, Phillips, Allen, Scrulox, hex, and clutch head screws, plus hex nuts. See-through container has a positive snap-lock. PS-6 includes miniature drivers for No. 00, 0, and 1 Phillips; 3/32", 1/8", and 5/32" slotted

Why pay an answering service when you can own your own?



Dictaphone has a machine to make sure you never lose another cent through a missed phone call or a garbled message. In fact, we have a whole line of them.

They're called Ansafones. You can buy one outright or possibly lease it for about what you're paying your answering service now. And it works for you 24 hours a day, 7 days a week.

Call this toll-free number: 800-851-3360. From Ill. call 1-800-642-3372. Or send the coupon below.

▶ Dictaphone

Box L-7-34, 120 Old Post Road, Rye, New York 10580

Please send me full details of the Ansafone line.

Name _____

Company _____ Phone _____

Address _____

City _____ State _____ Zip Code _____

Ansafone and Dictaphone are registered trademarks of Dictaphone Corp.

Circle 61 on reader service card



Antenna Specialists Monitor Preamplifiers

- Three models: *MON-25* covers high band, 148-174 MHz \$29.95; *Mon-26* covers low and high band, 30-50 and 148-174 MHz \$39.95; *MON-28* covers UHF band, 450-470 MHz \$29.95.
- High amplification, broad band design—20dB on any band.
- Operates on single 9-volt battery (not supplied) for mobile. For base, use battery eliminator.
- Mobile mounting bracket and connecting coax with pin plug. Pinjack for antenna connection.

the antenna specialists co.



Div. of **alken** Electric & Equipment Co.
12435 Euclid Ave., Cleveland, Ohio 44106
Export: 2200 Shames Dr., Westbury, L.I., N.Y. 11590
Canada: A. C. Simmonds & Sons, Ltd.

Circle 62 on reader service card

ELECTRONIC TECHNICIANS!

Raise your professional standing
and prepare for promotion! Win
your diploma in

ENGINEERING MATHEMATICS

from the Indiana Home
Study Institute

We are proud to announce two great
new courses in Engineering Mathematics
for the electronic industry.

These unusual courses are the result of
many years of study and thought by the
President of Indiana Home Study, who has
personally lectured in the classroom
to *thousands* of men, from all walks of
life, on mathematics, and electrical and
electronic engineering.

You will have to see the lessons to appreciate them!

NOW you can master engineering
mathematics and actually *enjoy* doing it!
WE ARE THIS SURE: you sign no
contracts—you order your lessons on a
money-back guarantee.

In plain language, *if you aren't satisfied*
you don't pay, and there are no strings
attached.

Write today for more information and
your outline of courses.

You have nothing to lose, and every-
thing to gain!

The INDIANA HOME STUDY INSTITUTE

Dept. RE-7, P.O. Box 1189, Panama City, Fla. 32401

Circle 63 on reader service card

screws. *PS-140* has drivers for No. 0, 1, and 2 Phillips screws; 3/32", 1/8", 3/16", and 1/4" slotted screws; and 1/4", 5/16", and 3/8" hex nuts. *PS-130* has a larger assortment of nutdrivers and drivers.—**Xcelite Inc.**, Orchard Park, N.Y. 14127.

Circle 41 on reader service card

DAMPER DIODE, R-DW4 Solid Tube. Solid-state damper diode for direct, plug-in replacement of damper tubes 6DW4, 6CK3, 6CL3 and 6BA3 in color TV receivers. Peak inverse voltage, 6kV, peak repetitive forward current, 1300mA, and average forward current, 250mA. Voltage

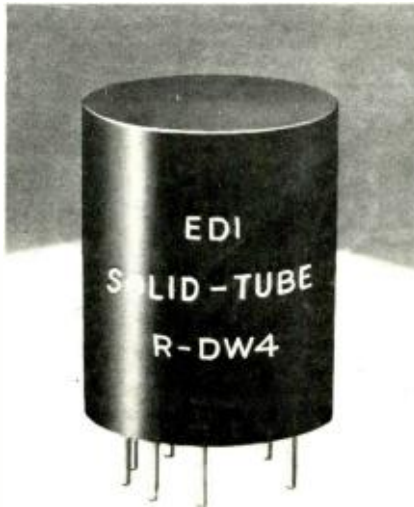

drop is 10V at 350mA. Operating without a filament, the *R-DW4* solid-state damper diode runs considerably cooler than vacuum tubes to provide longer life as well as greater reliability.—**Electronic Devices, Inc. (EDI)**, 21 Gray Oaks Ave., Yonkers, N.Y. 10710.

Circle 42 on reader service card

DIGITAL MULTIMETER, model 167. Digital-readout display is at top of hand-held probe. Measures multitude of signals quickly without having to turn back to a front-panel display to check the data. The probe stores in front panel and unit is used



just like conventional multimeter. 3 1/2 digit LED display, automatic ranging, dc volts from 1mV to 1kV; ac volts from 1mV to 500V; ohms from 1 ohm to 20 megohms. Battery-powered, optional ac and dc power. Full overload protection. Input impedance 55 megohms shunted by approxi-

mately 220 pF. \$325.00.—**Keithley Instruments, Inc.**, 28775 Aurora Road, Cleveland, Ohio 44139.

Circle 43 on reader service card

INSTANT CONTACT CLEANER, LPS. Chemically pure, gentle fluoro-carbon solvent cleaner. High density-low surface tension-controlled solvent power quickly removes oil, grease, organic matter from electrical and mechanical instruments and controls with no effect on the equipment being cleaned. Excellent for cleaning



electric motors, relays and switches; film, tape and tape heads; printed circuits, tuners, precision instruments; multitude of other jobs not open to harsh cleaners. Non-toxic, non-flammable, non-explosive, nonconductive, and leaves no residue.—**LPS Research Labs Inc.**, 2050 Cotner Ave., Los Angeles, Calif. 90025.

Circle 44 on reader service card

MULTIMETER, model FE160. has 112 pushbutton-selected ranges. Meter has both high- and low-ohms power range. This feature is specified on many new schematics for in-circuit resistance measurements of IC's that cannot be disconnected. Features low-voltage range of



0.1 volt full scale for transistor bias measurements and 30- μ A low scale current for base current and other such measurements. 1.5% accuracy dc and 2.5% ac; meter protection to 1000 times. \$190.00.—**Sencore, Inc.**, 3200 Sencore Drive, Sioux Falls, S.D. 57107.

R-E

Circle 45 on reader service card

new lit

All booklets, catalogs, charts, data sheets and other literature listed here with a Reader Service number are free for the asking. Turn to the Reader Service card on page 103 and circle the numbers of the items you want. Then mail the postage-paid card.

ALARM CATALOG. Equipment for commercial, residential, and vehicle alarm needs. Complete burglar alarm systems, from straight mechanical to solid-state electronic; telephone dialing alarms, to send automatic messages to police or fire departments; wireless remote units. Also includes a wide range of components and accessories: bells, sirens, alarm-shunting locks, and a wide range of contacts (window, door and other switches). Floor-mat contacts, electric eye detectors, thermostatic fire detectors, and even an oscillating TV camera for surveillance use, are listed, and a special section of the catalog covers vehicle alarms.—**Universal Security Instruments, Inc.**, 2829 Potee St., Baltimore, Md. 21225.

Circle 46 on reader service card

SURPLUS CATALOG, bargains in electronic, optic, horologic and other items of interest to the scientist, amateur, engineer, or just tinkerer. Features such diverse items as integrated-circuit and magnetic-core memories, navigator's pocket chronometer, microprojection lens and a wide assortment of solid-state light emitters and detectors, all at fractions of their commercial prices.—**B & F Enterprises, P.O. Box 44, Hathorne, Mass 01937.**

Circle 47 on reader service card

EXPERIMENTERS' PARTS CATALOG, No. 6B, 1972. Contains a large selection of transformers, resistors, capacitors, semiconductors of all kinds, integrated circuits and special items (millivoltmeter, parts removed from retired computers, latch switches, etc.)—**Delta Electronics, P.O. Box 1, Lynn, Mass. 01903.**

Circle 48 on reader service card

TEST EQUIPMENT & ACCESSORIES CATALOG, for servicing radio, phonographs, tape and TV, industrial maintenance, laboratory analysis, and schools. This 36-page brochure shows photographs and specifications on vom's, oscilloscopes, signal generators, transistor testers, picture-tube testers, power supplies, probes and accessories.—**RCA Electronic Components, Harrison, N.J. 07029.**

Circle 49 on reader service card

SECURITY BROCHURE, Dialtronic, gives complete details on the model DT/2000/A automatic alarm communicator, along with spec sheet on the *Radar Sentry Alarm* with 101-watt electronic siren.—**Radar Devices Mfg. Co., 22003 Harper Ave., St. Clair Shores, Mich. 48080.**

Circle 50 on reader service card

EPOXY RECTIFIERS

FIRST GRADE

1A-1000 PIV

5 for \$100

D122



SLIDE SWITCHES
12 for \$100

All types, SPDT, DPDT, etc. D106

TRANSISTOR REPAIR KIT
\$100

Includes resistors, condensers, transistors, transformers and various & sundry parts used to repair transistor radios, walkie-talkies, tape recorders, etc.

D107



RADIO & HI-FI KNOBS
100 for \$100

All different types, shapes & colors. Some with set screws. others for knurled shafts. D112

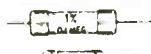

PRECISION RESISTORS

All 1%, 1/2 watts & 1 watts. From low to high ohmages. 60 for \$100

D113

BARrier TERMINAL BLOCKS



20 assorted for \$100

These are seconds from 2.14 terminals. Some screws missing. All functional. D126

FUSE



HOLDERS
4 for \$100

Standard, for 3AG fuses. D129

NC188 100 PC. GIANT PACK OF ASSORTED TRANSISTORS

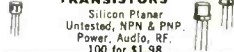

MONEY BACK GUARANTEE

Terms: Minimum order \$3.00. Include postage. Either full payment with order or 20% deposit, balance C.O.D.

FREE CATALOG

BARGAIN BONANZA OF EDLIE HIGHEST QUALITY KITS

ONLY NEW PRODUCTS
EXCELLENT MIXTURE
FULL YEAR GUAR.
RADIO & TV RECEIVING TUBES

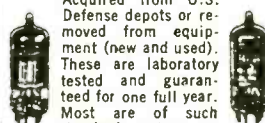

Acquired from U.S. Defense depots or removed from equipment (new and used). These are laboratory tested and guaranteed for one full year. Most are of such standard makers as RCA, GE, etc.

3 Tubes for \$1.00

1L4, 1S4, 1S5, 1U4, 3A3, 3AV6, 3BC5, 3DK6, 3DT6, 3Q4, 4BN6, 4BZ7, 4DE6, 5AN8, 5AS8, 5AT8, 5CQ8, 6AG5, 6AH4, 6AM6, 6AN5, 6AF9, 6AU5, 6AV5, 6AX4, 6AY3, 6AX5, 6AZ8, 6BC5, 6BG6, 6BH6, 6BR8, 6CG7, 6CG8, 6CH8, 6CL8, 6CM7, 6CW5, 6DR7, 6DS5, 6DQ6, 6DT8, 6DW4, 6DX8, 6EB8, 6EJ7, 6EM5, 6EM7, 6EV7, 6FQ7, 6GF7, 6GH8, 6HB7, 6HS5, 6J6, 6JC6, 6JE6, 6JW8, 6JM6, 6JS6, 6K6, 6LE8, 6LY8, 6SV7, 6S4, 6V4, 6W4, 6CS7, 8CX8, 8EB8, 10CW5, 10DE7, 12AZ7, 12EK6, 12EN6, 12GN7, 13EM7, 17D4, 17DQ6, 17JM6, 17H3, 22DE4, 25C5, 25Z6, 27, 28D7, 38HE7, 55.

WRITE FOR FREE VALUE PACKED CATALOG

BONUS

FREE TRANSISTOR KIT

for any \$5.00 Kit purchase

EDLIE ELECTRONICS, INC.

2700 D HEMPSTEAD TPKE., LEVITTOWN, N.Y. 11756

Circle 64 on reader service card

1/2 WATT CARBONS

100 for \$100

All standard ohmages, some 5%. Standard makes. D150

CARBON RESISTORS

200 for \$100

Most with cut leads (long enough for soldering), some pre-formed. Most all 5% or 10%. D136

POWER RESISTORS



35 for \$100

Consists of standard makes such as Clarostat, Sprague, etc. Assorted ohmages & wattages. D109

DISC CAPACITORS



60 for \$100

Assorted capacitances from 0001 to .1. Different voltages, mostly 600 volts N.P.O. N750. D140

MINIATURE TRANSISTOR ELECTROLYTES

12 for \$100

Some axial leads, some vertical mount, mixed capacitances and mixed voltages. D121

1 WATT CARBON RESISTORS

70 for \$100

All standard ohmages, some 5%. Standard makes. D145



MINIATURE POTS
12 for \$100

Used in transistor and miniature applications. D141



CRYSTALS
6 for \$100

Some for receiving or transmitting; some CB, some Ham, some business band, in different type holders. D144



RELAYS
4 for \$100

Assorted types, from 6 volts to 110 volts. Some sell for as much as \$10.00. D155

Fight Them All

Heart Attack, Stroke
High Blood Pressure
Rheumatic Fever



GIVE...so more will live HEART FUND

**New and only
from EICO...
The Professional Home
Protection everyone can
Install and Afford!**

EICO FC-100 SECURITY CONTROL CENTER

- Start your custom Burglar/Hold-up/Fire Alarm System with the FC-100.
- Add on Sensors, Alarms and Accessories to suit your own needs.
- "Do-It-Yourself" Installers Handbook included.
- No technical knowledge needed-No soldering.
- Ideal for Apartment, Home and certain Commercial Installations.
- 100% Professional in Design, Reliability, Performance.

The FC-100 is an extremely flexible home protection device. It has been designed for use with all types of intruder and fire sensors. The alarm activating circuits accommodate burglar alarm bells, separate fire horns, as well as various combinations of fire and burglar alarm bells and horns. A Remote Station Control with signal lights (EICO A-65) can be installed at any number of locations to show that all doors and windows are closed and the alarm system is ready to be "armed." The simple circuit uses only two wires. For maximum safety, the fire alarm circuits are always on and cannot be turned off accidentally.



The EICO FC-100 Security Control Center is powered by a 117 VAC Power Supply (EICO A-75) which supplies 6 volts DC for operating the system. Space is provided for an optional standard 6 volt lantern

battery for standby/emergency operation. In the event of an electrical power failure, the battery automatically supplies the power to keep the alarm system activated.

Each circuit in the EICO FC-100 has its own independent set of screw terminals that allow installation by someone unfamiliar with electrical wiring.

Model FC-100 \$69.95

EICO SS-500 BURGLAR/HOLD-UP/FIRE ALARM SYSTEM

- Systems "HEART" is the EICO FC-100 Security Control Center.
- Additional Sensors, Alarms, Accessories may be added any time to meet future needs.
- "Do-it-Yourself" Installers Handbook included.

A basic home Burglar/Hold-Up/Fire Alarm Systems which combines a high reliability alarm control center with detectors, alarm accessories and an alarm bell.

The SS-500 system is supplied with the following: A-75 Power Supply; SA-25 8" Alarm Bell; A-45 Entrance Key-Switch with "system-on" signal light; A-65 remote station control with signal lights; SD-20 Fire Sensors; SD-10, Door/Window Contact Switches; SD-50 Tamper Switches; SD-40 Door Cords; A-35 Emergency Buttons; A-95 Installers Handbook; A-105 "Home Protected" Decals and 250 feet of hook-up wire. Additional remote stations, entrance key switches, alarm bells, signal horns as well as fire, smoke, intruder, freeze-up and water flooding detectors, are available as optional accessories.

Model SS-500 \$129.95

"Do-it Yourself" HOME SECURITY HANDBOOK

A comprehensive 40-page Homeowners Handbook which includes a wealth of information on professional home security as well as comprehensive installation procedures in clear non-technical language.

A-95 Handbook \$2.95

FREE 32 PAGE EICO CATALOG

For latest catalog on EICO Burglar/Fire Alarm Systems, Environmental Lighting, Test Instruments, Stereo, EICOCRAFT Projects, and name of nearest EICO Distributor, check Reader Service Card or send 25¢ for First Class mail service.

EICO, 283 Malta Street, Brooklyn, New York 11207



Circle 65 on reader service card

76 RADIO-ELECTRONICS • JULY 1972

new ohmmeter circuit THE LOW-

by WALTER CERVENY*

A unique low-power ohmmeter circuit in a vom is a tremendous aid to engineers and technicians in troubleshooting and analyzing complex semiconductor and IC circuits. LP OHMS (Low-Power Ohms) is a special resistance measuring circuit used in Sencore and Triplet vom's. Triplet has two models that include this circuit, models 601 and 801.

Both units include two resistance measuring circuits, one called LP OHMS and the other CONVENTIONAL OHMS. The conventional ohms circuit use a 1.5-volt battery as a power source and is commonly found in most modern vom's. The LP OHMS uses a special circuit with a very low voltage power

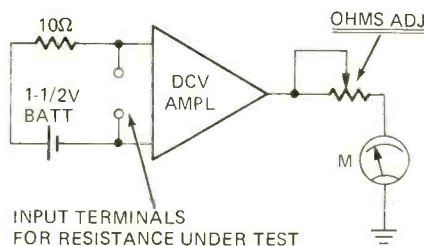

FIG. 1 CONVENTIONAL OHMS CIRCUIT

source. The model 601 has a source voltage of 75 mV and the 801 a mere 35 mV. Figures 1 and 2 illustrate conventional and LP Ohms circuits.

Figure 1 shows one range ($R \times 1$) of a conventional ohms

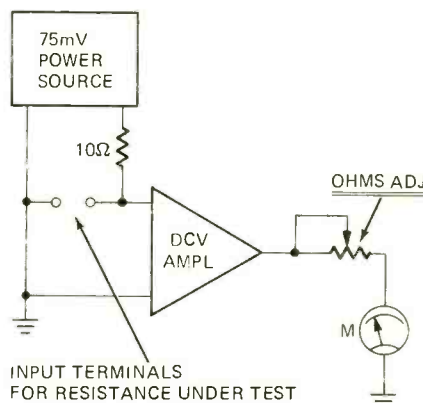

FIG. 2 LP OHMS CIRCUIT

circuit. With the input terminals open the OHMS ADJUST control is set for full scale. This means that the dc voltage amplifier (DCV amp) and meter are set to a sensitivity of 1.5 volt, the battery voltage. If the input terminals are shorted the meter reads zero. If we connect a 10-ohm resistor across the terminals the meter reads half scale since the two 10-ohm resistors form a voltage divider to halve the voltage.

Figure 2 shows a LP Ohms circuit with a 75-mV power source. The impedance of the power source is low, a few milliohms. The DCV amplifier and meter has a sensitivity of 75 mV with open terminals. The circuit operates in a similar fashion to conventional ohmmeters. The special circuits are

*Mgr. Engineering, Triplet Corp.

Does your mother-in-



law call you a meatball?

Does your boss?

Maybe even your wife? On payday.

Know what? If you have read this far, you are not meatball material. Because meatballs don't face the present, the future, the facts. They stay put. Dreaming and talking. And today, more than ever staying put means falling behind. Pretty tragic in a time when people with specific aptitudes are so necessary in so many interesting fields.

Today huge industries depend on people with electronics training.

Today there is a course of action that may lead you toward these well-paying, vital positions. It is RCA Institutes.

RCA Institutes is not for meatballs. RCA Institutes trains you for the fields where the action is: Computers • Color TV • Automation • Communications • Industrial Electronics • And more.

RCA Institutes not only has years of experience, it has an exclusive line-up of tested methods:

1. Hands-On Training

Over 250 interesting experiments. As many as 22 kits with some of the programs.

2. RCA Autotext

The easy-way-to-learn method that gets you started easier, faster.

3. Wide choice of courses and programs

Training in electronics fundamentals right up to solid state technology and communications electronics.

4. Low-Cost Tuition Plans

You'll find the one just made to fit your own budget.

5. FCC License Training Money-Back Agreement

RCA Institutes' money-back agreement assures you of your money back if you fail to pass the FCC examination taken within six months after completing RCA Institutes' FCC course.

RCA Institutes gets your training started even if you've not had previous experience or training. Just bring us your interest.

Set your own pace depending on your schedule.

If you like to tinker, fiddle, fix, put that ability to work to do a real repair job on your future now.

Don't wait. Get complete information right now. No obligation. Except to yourself. Send us the attached postcard. Or return the coupon.

Veterans: Train under GI Bill. Accredited Member National Home Study Council. RCA Institutes, Inc. is licensed by—and its courses of study and instruction facilities approved by—the N.Y. State Education Department.

RCA Institutes

Home Study Department 758-207-0
320 W. 31 Street, New York, N.Y. 10001

Please rush me FREE illustrated electronics career catalog. I understand that I am under no obligation.

NAME _____

ADDRESS _____

CITY _____ STATE _____ ZIP _____

Veterans check here

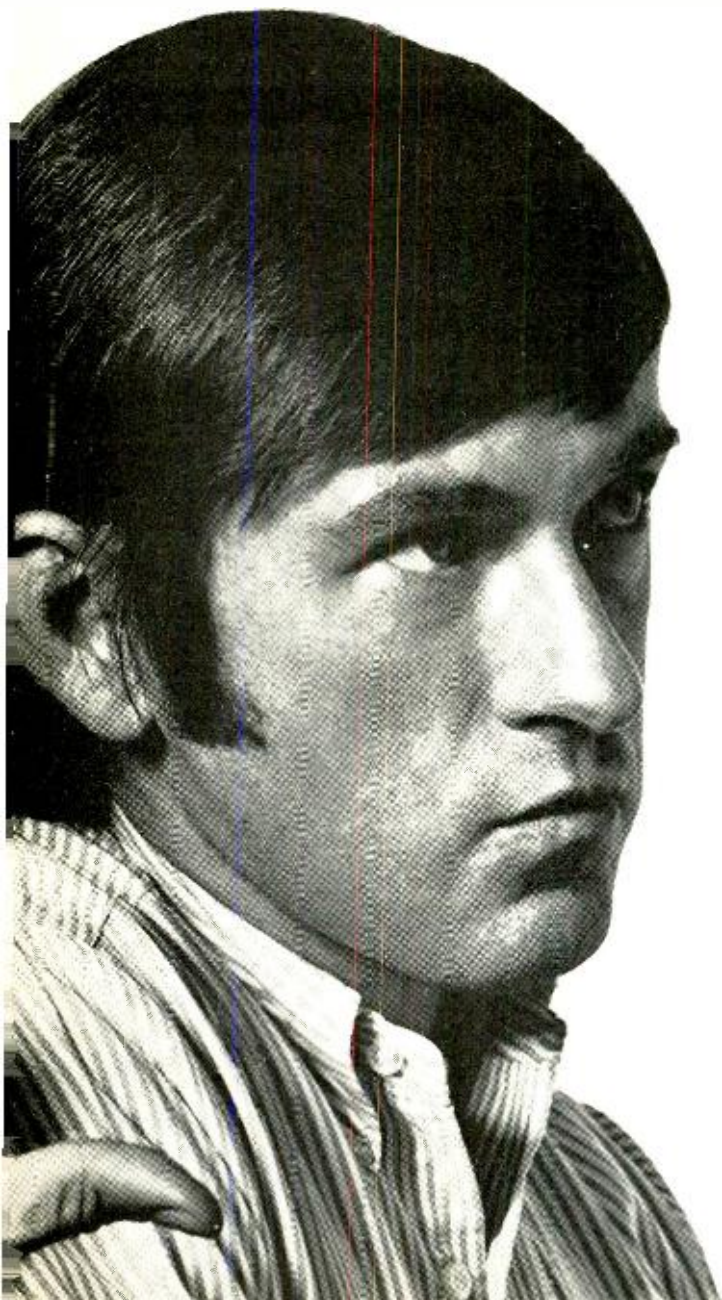

LOW OHMS STORY

(continued from page 77)

make troubleshooting and repair of equipment with IC's much easier and faster.

Here are some of the techniques that can be used to ser-

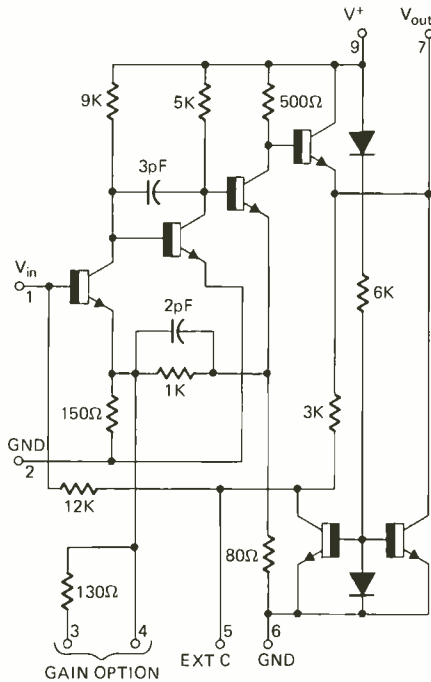

FIG 3

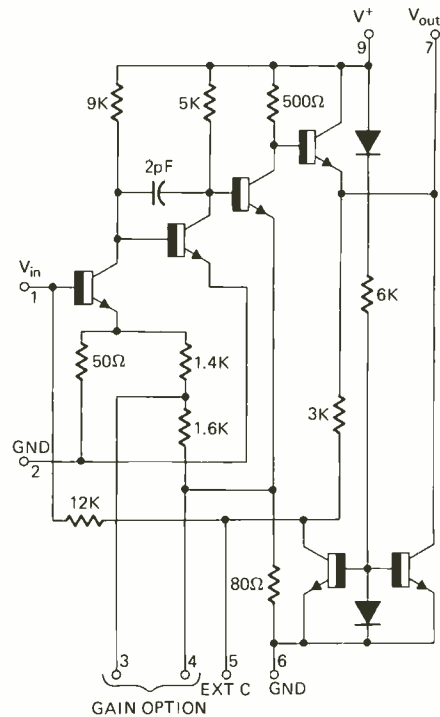

FIG 4

vice equipment with IC's (see Fig. 3 and Fig. 4).

Shorts—To determine whether an IC is shorted, connect the LP Ohm Ohmmeter across V + and ground. If the reading is low in resistance, it can be assumed that one of the semiconductors is shorted. Test-lead polarity does not matter since the semiconductors will not conduct with the low voltage applied by the LP Ohms circuit.

Measure resistors in the IC.—For example, between EXT. C and V out, there is a 3,000-ohm resistance and it should read correctly, since we need not be concerned about the shunting effect of semiconductors. Another example is the 150-ohm resistance between pins of 2 and 4 of Fig. 3.

Test transistors for leakage, connect LP Ohms meter between V in Pin 1 and Pin 4 or V + and V out of Figure 3. This can be done with the vom set up for high resistance to detect small leakage currents.

These tests are just a few checks that can be made with a LP Ohms vom. With a little ingenuity and a schematic any IC can be evaluated.

R-E

DIGI-DYNA-CHECK KITS AND MANUAL READY

A great many readers have mentioned problems in obtaining parts for the Digi-Dyna-Check described in this and the two previous issues. A revised programming manual and two kits of parts are now ready. Details on page 94.

“Further progress in the difficult field of and

will come only when millions of Americans know enough, care enough, and are willing to work together hard enough to make it come.”

YOU CAN MAKE A DIFFERENCE



SUPPORT YOUR MENTAL HEALTH ASSOCIATION

Citizens Who DO Make A Difference

WILLIAM C. MERRINGER, M.D. (1900-1982)

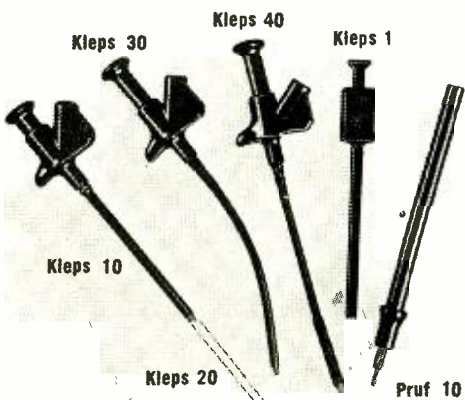

Clever Kleps

Test probes designed by your needs — Push to seize, push to release (all Kleps spring loaded).

- Kleps 10.** Boathook clamp grips wires, lugs, terminals. Accepts banana plug or bare wire lead. 4¾" long. \$1.19
- Kleps 20.** Same, but 7" long. \$1.39
- Kleps 30.** Completely flexible. Forked-tongue gripper. Accepts banana plug or bare lead. 6" long. \$1.47
- Kleps 40.** Completely flexible. 3-segment automatic collet firmly grips wire ends, PC-board terminals, connector pins. Accepts banana plug or plain wire. 6¼" long. \$2.39
- Kleps 1.** Economy Kleps for light line work (not lab quality). Meshing claws. 4½" long. \$.99
- Pruf 10.** Versatile test prod. Solder connection. Molded phenolic. Doubles as scribing tool. "Bunch" pin fits banana jack. Phone tip. 5½" long. \$.79



Available through your local distributor, or write to:
RYE INDUSTRIES INC.
 128 Spencer Place, Mamaroneck, N.Y. 10543
 In Canada: Rye Industries (Canada) Ltd.

Circle 67 on reader service card

COUNTER DISPLAY KIT-CD-2

This kit provides a highly sophisticated display section module for clocks, counter or other numerical display needs. The RCA DR-2010 Numitron display tube supplied with this kit is an incandescent seven segment display tube. The .6" high number can be read at a distance of thirty feet. RCA specs. provide a minimum life for this tube of 100,000 hours (about 11 years of normal use).

A 7490 decade counter IC is used to give typical count rates of up to thirty MHz. A 7475 is used to store the BCD information during the counting period to ensure a non-blinking display. Stored BCD data from the 7475 is decoded using a 7447 seven segment decoder driver. The 7447 accomplishes blanking of leading edge zeroes, and has a lamp test input which causes all seven segments of the display tube to light.

Kit includes a two sided (with plated through holes) fiberglass printed circuit board, three IC's, DR-2010 (with decimal point) display tube, and enough Molex socket pins for the IC's . . .

Circuit board is 8" wide and 4 3/4" long. A single 5 volt power source powers both the IC's and the display tube . . .

Board only **\$ 2.50**
 CD-2 kit complete only **\$10.95**
 assembled and tested **\$13.00**

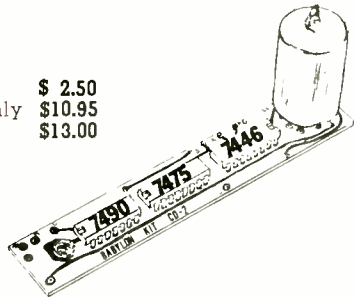

SUPER DIGITAL SPECIAL

This has to be the greatest buy of IC's ever offered. These are brand new Signetic 8424 dual low power RS/T flip flops. These are first quality IC's, dual in line and packaged in the factory piastic carrier.

RS/T flip flop is a Signetics description of a latch which includes the steering logic to provide a toggle function. These IC's can divide by two with input frequencies of up to 12 MHz. (8 MHz. guaranteed minimum).

The Signetic low power 84xx series is fully compatible with other TTL lines and its low power consumption is a great help with large scale use (such as music synthesizers). Each package (two FF) operates at 5 volts and 5ma. (typical—with 10ma maximum) . . .

With data sheets and two pages of application notes.

EACH **\$.35**
 TEN **3.00**
 100 **25.00**
 1000 **200.00**

UNIVERSAL COUNTER DISPLAY KIT CD-3

This kit is similar to the CD-2 except for the following:

- does not include the 7475 quad latch storage feature.
- board is the same width but is 1" shorter.
- five additional passive components are provided, which permit the user to program the count to **any** number from two to ten. Two kits may be interconnected to count to any number 2-99, three kits 2-999 etc.
- complete instructions are provided to preset the modulus for your application.

CD-3 board only **\$2.25**
 IC's 7490, 7447 **2.75**
 RCA DR2010 tube **5.00**

Complete kit includes all of the above-plus, 5 programming parts, instructions, and molex pins for IC's
 only **\$9.25**



256 BIT BI-POLAR FIELD PROGRAMMABLE READ ONLY MEMORY

This Signetic #8223 IC operates at 5 volts and contains 32 x 8 bit wide ROM which can be field programmed.

Each **\$10.00**

We can provide these devices programmed to your specifications @ **\$5.00** for the first one and **\$2.00** each additional one. Please allow one week for programmed units.



RCA DR2010 Numitron digital display tube. This incandescent five volt seven segment device provides a .6" high numeral which can be seen at a distance of 30 feet. The tube has a standard nine pin base (solderable) and a left hand decimal point.

Each **\$5.00** SPECIAL 5 for **\$20.**

LED DISPLAY

Seven segment diffused planar GaAsP light emitting diode array. It is mounted on a dual in line 14 pin substrate and then encapsulated in clear epoxy for protection. It is capable of displaying all digits and nine distinct letters . . .

FEATURES:

- High brightness . . . typically 350ft-L @ 20ma
- Single plane, wide angle viewing. . . . 150°
- Unobstructed emitting surface
- Standard 14 pin dual in line package
- Long operating life . . . Solid state
- Operates with IC voltage requirements

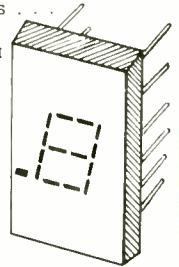

ONLY **\$4.25** each

DIODES BY THE FOOT

High quality Germanium signal diodes made by Transition. These are brand new first quality devices on tape carrier.

These diodes are branded and banded at the cathode end, but do not have a 1Nxx marking, I checked and measured a forward voltage of .35 volts @ 20 ma., and .58 volts at a continuous 100ma. . . .

1 foot (60 diodes) only **\$2.95** less than **.05¢** each . . .

We have Silicon diodes (signal) at the same price as the above, please specify

LM309K—5 volt regulator



This TO-3 device is a complete regulator on a chip. The 309 is virtually blowout proof, it is designed to shut itself off with overload of current drain or over temperature operation.

Input voltage (DC) can range from 10 to 30 volts and the output will be five volts (tolerance is worst case TTL requirement) at current of up to one ampere . . .

EACH **\$2.50** FIVE for **\$10.00**

M-50 red emitting 10-40ma @ 2V **.60**
 10 for **\$5.00**

M-2 Invisible infrared emitter high power 1A @ 1.5V TO-5 **3.00**



M-10B Visible red emitter 5-70ma @ 2V **.75**



LSI-Calculator on a Chip

This 40 pin DIP device contains a complete 12 (twelve) digit calculator, Add, subtract, multiply, and divide. Outputs are multiplexed 7 segment MOS levels. Input is BCD MOS levels. External clock is required. Complete data is provided with chip (includes schematic for a complete calculator). **\$14.95** complete with data

Orders for \$5.00 or more will be shipped prepaid. Orders over \$25.00 will be shipped via AIR MAIL prepaid. IC and transistor orders are shipped within two workdays of receipt. Kit orders are shipped within ten days of receipt. Purchase orders accepted from rated firms and government agencies. Minimum open account order is **\$25.00**.

—All goods described in this flyer are new unused surplus, unless described otherwise in special offerings. All goods are sold on a money back guarantee.

PLEASE TYPE OR PRINT YOUR NAME AND ADDRESS ON THE ORDER.

BABYLON ELECTRONICS

P.O. BOX J
 CARMICHAEL, CALIFORNIA 95608
 (916) 966-2111



SAVE MONEY!

A Delta Mark Ten Capacitive Discharge Ignition (CDI) System On Your Car Slashes Maintenance Costs And Increases Performance.

Put a Mark Ten on your car and save by eliminating 3 out of 4 tune-ups. Save as gasoline mileage increases (up to 20%). The Mark Ten CDI System also extends spark plug life, promotes more complete combustion and assures instant starts in all weather. It operates on any 6 or 12 volt negative or positive ground system.

The Mark Ten B affords additional money saving advantages by drastically reducing combustion contaminants and restoring power lost by the use of smog control devices. Equipped with handy switch for instant return to standard ignition, the Mark Ten B works with ANY 12 volt negative ground engine. Both systems install in ten minutes without rewiring.

Order your Mark Ten or Mark Ten B today. Save money while you enjoy low maintenance and increased performance.

Mark Ten (Assembled) \$44.95 ppd.

Mark Ten (Deltakit) \$29.95 ppd.

(Kits available in 12 volt only, positive or negative ground)

Mark Ten B \$59.95 ppd.

(12 volt negative ground only)

Superior Products at Sensible Prices
Mfg. in U.S.A.



DELTA PRODUCTS, INC.

P.O. BOX 1147 • GRAND JUNCTION, COLORADO 81501
PHONE (303) 242-9000

Please send me literature immediately:

Enclosed is \$ _____

Ship ppd. Ship C.O.D.

Please send: _____ Mark Ten B @ \$59.95 ppd.

___ Standard Mark Ten (Assembled) @ \$44.95 ppd.

___ 6 Volt: Neg. Ground Only ___ Positive Ground

___ 12 Volt: Specify _____ Negative Ground

___ Standard Mark Ten (Deltakit™) @ \$29.95 ppd.

(12 Volt Positive Or Negative Ground Only)

Car Year _____ Make _____

Name _____

Address _____

City/State _____ Zip _____

Dept. RE

APPLIANCE CLINIC

(continued from page 22)

winding on the toroidal core is the key to the whole process. As long as only normal currents flow in the circuit, no voltage is induced in this winding.

When there is a ground-fault from either of the hot wires to earth, current flows. It creates an unbalance and a voltage is induced in the sensor winding. This causes the sensor unit to energize the trip-coil (it uses the power from the line to do this) and open the hot sides of the circuit in the very short time mentioned.

Commercial units, such as those made by the Harvey Hubbell Co. of Bridgeport, Conn. have over-current ratings of 15 and 20 amperes, sensitivity of 5.0 mA fault-current, and a trip-time of .025 second. These units use the differential-transformer sensor, and the glass-enclosed reed switches for the actual tripping of the coils. There are other companies making these units. Some are standard box-mountings for home use. There is also a portable unit, with an extension cord, for the protection of workmen, handymen, and any use where there is danger of shock from electric tools or equipment.

They are required by the NFPA Code for all electrical outlets within 15 feet of swimming pools. Later on, this could be extended to other areas of the home where dampness and electrical equipment meet—laundry rooms, and even kitchens or baths.

There are complications, of course. If you should install one of these devices, only to find that it won't stay in but trips instantly, stop. You have very likely got some leakage in your wiring! Older houses, water-soaked conduit wiring, faulty appliances, etc. will trip the gfi. This is an indication of a hazardous condition and it had better be found and fixed! In January 1969 the National Standards Institute issued a new Standard for leakage current in appliances. This allowed 0.5 mA or less of leakage in all cord-connected units. If you have a leakage greater than the 5-mA trip current of the gfi, it won't stay in, but it's trying to tell you something!

These things are not cheap; that is, compared to the cost of the older over-current protection devices like circuit breakers. However, when you think of what they could save—this includes your life, and/or your children's lives—they are! They will protect against possible lethal shocks, and this is pretty much priceless! R-E

DIGITAL ELECTRONIC STOPWATCH

Accurate to 1/10 second, with a 5-digit readout, this build-it-yourself timer is great for any kind of sporting event. Build it from the August issue.

Don't let this familiar face fool you.

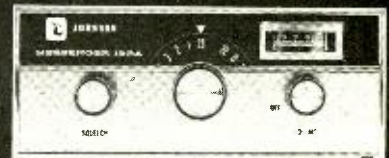

Messenger 123A is all new inside.

We've taken our most popular 23-channel CB two-way radio and given it completely new circuitry! New ceramic filter for great selectivity. New acoustically isolated speaker for clearer sound. And more. All for a suggested price of \$149.95.

You're going to hear more from...



JOHNSON

Waseca, Minnesota 56093

Circle 70 on reader service card

FREE catalog

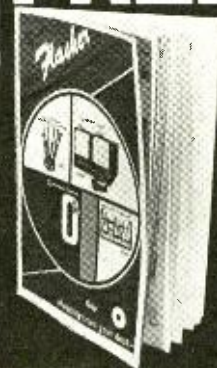

over **1000** unique tools, handy kits, precision instruments, technical supplies.

Our 20th year of service to the World's finest craftsmen and technicians.

Send a FREE copy of the NC Flasher

Name _____

Address _____

City _____

State _____

Zip _____

National Camera
2000 West Union Ave. Dept. G88
Englewood, Colorado, 80110

Circle 71 on reader service card

ADD INTENSITY CONTROL TO IO-21 SCOPE

Here is a way to add an intensity control to your IO-21 and similar scopes. The only new parts needed are a 1-megohm linear potentiometer, a 100,000-ohm 1/2-watt resistor, a 1-lug terminal strip and a small matching Heathkit knob. Study the diagrams and drawing and then follow me step-by-step:

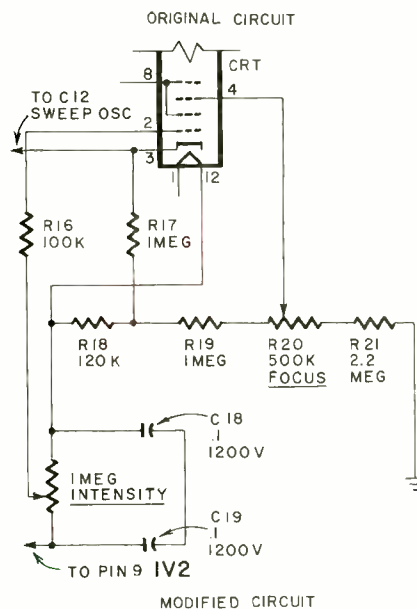
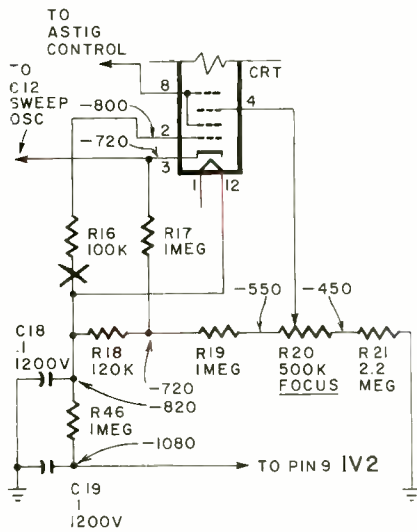

1. Drill a 7/16 inch diameter hole in the panel to the right of the crt. Mount the control in the hole with the lugs pointing down and install the knob.
2. Drill a hole in the crt mounting bracket above the FOCUS control and mount the terminal strip.
3. Remove the 100,000-ohm resistor connected between pins 2 and 12 of the crt socket.
4. Using insulated sleeving on both leads, connect the new 100,000-ohm resistor between pin 2 of the crt socket and the new terminal strip.

5. Connect a wire between the terminal strip and the center lug of the new control.

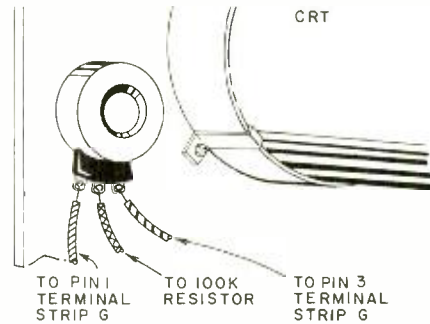

6. Remove the 1-meg resistor (R46) connected between the high-voltage filter capacitors on terminal strip G.
7. Connect a wire between terminal 1 of this terminal strip and the left lug on the INTENSITY control.
8. Connect a wire between terminal 3 (connected to pin 9 of the 1V2 socket) and the right lug of the new control.
9. Solder all connections. Keep all connections to the control away from the panel (high voltage is present at these points).—Joe Fishbein.

R-E

FREE CATALOG

Fast... Flameless
CONCENTRATED HEAT
up to 1000°F.



MILWAUKEE

HEAT-BLO GUN

The Heat Gun of a Thousand Uses

A model for every need ranging from 150° to 1000°F., without an open flame. Safe and easy to operate...use wherever concentrated heat is needed. Fingertip switch control permits operator to aim heat right at desired point. Temperature can be varied by air intake adjustment. Also blows cold air when desired.

MEETS DOZENS OF NEEDS in laboratory and on production lines...softens plastics...dries paint, glue or photo prints...thaws...defrosts...heat seals...does blister packs...preheats for welding or soldering...desoldering...excellent for softening, repairing and retexturing molded plastics...shrinks vinyl to fit upholstery.

Sturdy adjustable metal stand permits positioning on bench or machine, on assembly lines, etc.

MILWAUKEE LOCK & MFG. CO.
5078 N. 37TH STREET • MILWAUKEE, WIS. 53209

Circle 72 on reader service card

JULY 1972 • RADIO-ELECTRONICS 85

NEW, FREE FIRE/BURGLAR ALARM CATALOG

64 pages presenting 350 intrusion and fire alarm products for today's skilled alarm installers and electronic technicians. Includes the latest systems and detectors, hard-to-find parts, accessories, and technical application notes on uses and circuit designs.



**mountain west
alarm supply co.**

4215 NORTH 16th STREET
PHOENIX, ARIZONA 85016
Circle 73 on reader service card

EQUIPMENT REPORT

(continued from page 27)

possible in general for a measurement at a single bias point to yield useful information about a complex circuit. So while the ohmmeter method is basically sound it is impractical as a servicing technique simply because it is inconvenient and time consuming.

At the other end of the scale is the transistor curve tracer. Capable of both in and out-of circuit measurements the curve tracer in its more sophisticated form is mostly used for accurate tests of a device out of circuit. There is no reason, however, why it cannot be used in-circuit and the important concept it incorporates also used by the Quicktracer is operating the device over a series of different operating points and not the single bias point the ohmmeter method uses. Let's look at the Tektronix 576 curve tracer as used to display the common-emitter characteristics of transistors and to study the collector-base and emitter-base junctions. The Tektronix 576 is usually found in the circuit design laboratories of major electronic companies. Its \$2000 plus price tag puts it out of our reach but let's see some of the things it can do for later comparison.

Figure 1 is the common-emitter characteristic of a 2N2897 transistor displayed on the 576. The display includes fiber optic readouts which give positive identification to the deflection factors and parameter steps. (The parameters and test conditions indicated vertically along the right edge of the scope screen in Figs. 1, 2 and 3 are: 1 mA per vertical division, 2 volts per horizontal division, 20 μ A per step and beta or gm is 50 per

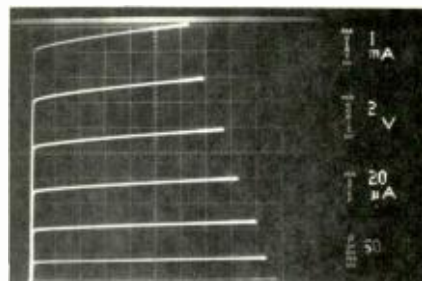

Fig. 1

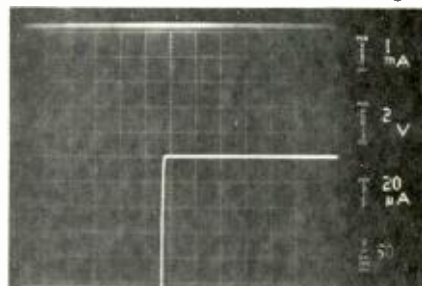

Fig. 2

"Values" That Defy All Competition

FREE \$1 BUY WITH EVERY 10 YOU ORDER Only applies to "\$1" Buys **FREE GIFT WITH EVERY ORDER**

- 70° COLOR TUBE BRIGHTNER \$3.95
- 90° COLOR TUBE BRIGHTNER \$4.95
- HEAVY DUTY COLOR FOCUS RECTIFIER 14,000 PIV @ 1 ma. . . \$1
- 50 - OIL IMPREGNATED TUBULAR CAPACITORS Porcelain, Axial Leads—Most popular values \$3.95
- COLOR-TV RECTIFIER — Used in most color sets—6500 kv \$1.95
- 15 - ASST. ROTARY SWITCHES all popular types \$20 value . . . \$1
- 15 - G.E. #NE-2 TUBES Neon Glow Lamp for 101 uses. . . \$1
- 30 - .005 DISC CERAMIC CAPACITORS C.R.L. \$1
- 1 - GE SHOW & TELL TONE ARM Exact replacement . . . \$2.49
- 7 - TV ELECTROLYTIC CONDENSERS desirable types . . . \$1
- 12 - MINIATURE ELECTROLYTIC CONDENSERS For Transistor & miniature work \$1
- 2 - ELECTROLYTIC CONDENSERS UNECAP . . . 2000/1000 Mfd . . . \$1
- 2 - BELFUSE #450-1 ad 3-1 RCA Replacement 945392-4 and 945392-3 \$1
- UHF OR VHF MATCHING TRANSFORMER Simple Pool-proof installation \$1
- 2 - ELECTROLYTIC CONDENSERS C.D. 500 mfd—200 volts . . . \$1
- STEREO HEADPHONES HI-FI Quality . . . Complete with Stereo plug \$5.95

- UHF TUNER — TRANSISTOR TYPE Used in all TV sets . . . \$3.95
- STANDARD TUNER — TRANSISTOR (GUIDED GRID) 4 Channel closed circuit \$1
- 20 - DIPPED MYLAR CAPACITORS .01—600V \$1
- 20 - DIPPED MYLAR CAPACITORS .033—600V \$1
- 20 - DIPPED MYLAR CAPACITORS .0033—1000 V \$1
- 20 - DIPPED MYLAR CAPACITORS .047—400 V. \$1
- 15 - MOLDED TUBULAR CAPACITORS .088—400 V. \$1
- 6 - MINIATURE ELECTROLYTIC CAPACITORS 5 MFD—150 V. . . \$1

SARKES TARZIAN TUNER
41mc

Latest Compact Model good for all 41 mc TV's.
BRAND NEW—

Best TUNER "SARKES TARZIAN" ever made—last word for stability, definition & smoothness of operation. An opportunity—to improve and bring your TV Receiver up-to-date.
\$7.95
COMPLETE with Tubes

- KNOB SPECIAL**
- 100 - ASSORTED RADIO KNOBS All standard types . . . \$1
 - 50 - TV KNOBS - POPULAR TYPES Mostly Selector & Fine Tuning \$1
 - 25 - VERTICAL LINEARITY KNOBS Long shank . . . Front mount . . . miniature assortment \$1
 - 20 - VERTICAL LINEARITY KNOBS . . . Side mount . . . Standard sizes \$1
 - 25 - KNURLED RADIO KNOBS Hard to get . . . Best selection \$1
 - 40 - DELUXE RADIO KNOBS Choice assortment . . . Popular types \$1
- ANY 6 KITS FOR \$5

- TRANSISTOR RADIO asst type good, bad, broken, as-is, potluck \$1.50
- TAPE RECORDER—assorted types good, bad, broken, as-is, potluck . . \$4
- 300 - ASST. 1/2 W RESISTORS Top Brand, Short Leads, Excellent Selection \$1
- 100—ASST 1/4 WATT RESISTORS stand, choice ohmages, some in 5% \$1
- 100—ASST 1/2 WATT RESISTORS stand, choice ohmages, some in 5% \$1
- 70 - ASST 1 WATT RESISTORS stand, choice ohmages, some in 5% \$1
- 35 - ASST 2 WATT RESISTORS stand, choice ohmages, some in 5% \$1
- 50 - PRECISION RESISTORS asst. list-price \$50 less 98% \$1
- 20 - ASSORTED WIREWOUND RESISTORS, 5, 10, 20 watt \$1
- 10—ASSORTED SLIDE SWITCHES SPST, SPDT, DPDT, etc. \$1

- 2 - COLORBURST QUARTZ CRYSTAL For Most Color TV sets 3579.545 KC \$1.89
- 2 - ELECTROLYTIC CAPACITORS CD — 40/40 MFD — 450 Volts \$1
- 2—ELECTROLYTIC CONDENSERS 2000 Mfd. — 50 V \$1
- 1—6" x 9" HEAVY DUTY 10 OZ. SPEAKER Ceramic Type \$3.69
- 8 Ohm \$1
- \$20 - SHURE M7D DIAMOND NEEDLE exact replacement . . . \$3
- SHURE M44 SERIES DIAMOND NEEDLE exact Replacement . . . \$4.69
- 4 - 9 VOLT MOTORS Excellent for hobbyist \$1
- 200' - #24 SOLID PUSH BACK WIRE Yellow or Black excellent buy \$1
- MATCHED PAIRS TRANSISTORS NPN & PNP (2N4252-2N2904) (2N2222-2N2907) Each set . . . \$1
- RONETTE STEREO CARTRIDGE latest dual sapphire flipover type . . \$2
- 6 - TRANSISTOR RADIO EARPIECES wires complete with plug . . . \$1
- 5 ASSTD. GLOBAL VARISISTOR Popular replacements for most COLOR TV \$1
- 10 - SETS PHONO PLUGS & PIN JACKS RCA type \$1
- 5—PRINTED CIRCUIT IF TRANSFORMERS 4-Lug. 456 KC \$1
- 25 - 3900-OHM-7w RESISTOR 10% Corning glass \$1
- 20 - 47-600V CONDENSERS White Ceramic C.D.—American . . \$1
- 13 PC. SCREWDRIVER & 4.95 NUTDRIVER SET reg \$8.95 . . .

IMMEDIATE DELIVERY . . . Scientific light packing for safe delivery at minimum cost.
HANDY WAY TO ORDER: Pencil mark or write amounts wanted in each box, place letter F in box for Free \$1 BUY. Enclose with check or money order, add extra for shipping. Tearsheets will be returned as packing slips in your order, plus lists of new offers.
Minimum Order \$3.00

Please specify refund on shipping overpayment desired: CHECK POSTAGE STAMPS MERCHANDISE (our choice) with advantage to customer

BROOKS RADIO & TV CORP., 487 Columbus Ave., New York, N. Y. 10024

212-874 5600
TELEPHONE

division.) Figure 2 is the collector-base characteristic of the same device. The 0 volts, 0 milliamperes point is right in the center of the screen. Since we are looking at a two-terminal device as far as the curve tracer is concerned I have taken no care to observe polarity when connecting the junction to the tracer. This is one of the reasons the Quick-tracer described later is so convenient. If the collector-base junction had been connected the other way the trace would simply be inverted both top to bottom and left to right. Notice that in one horizontal direction the current remains zero as the voltage is increased. This is the reverse diode characteristic. In the other horizontal direction the junction is forward biased and the current rapidly increases. This particular device is silicon and the forward voltage is in the order of 0.6 volts (remember that each horizontal division is 2 volts). An ordinary diode would produce the same characteristic display. Now looking at the base-emitter junction in Fig. 3 we see the reverse-diode characteristic extending to the left. Then abruptly at about 11 volts the current deviates rapidly away from zero. This is the avalanche breakdown of the junction. This is the useful characteristic used in the fabrication of Zener diodes. In fact an 11-volt Zener diode connected to the

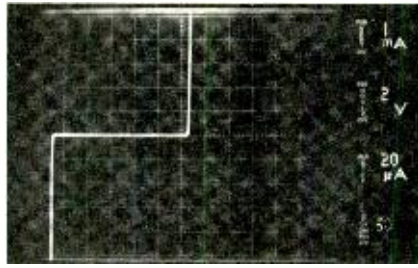

Fig. 3

curve tracer would produce the same display. In the other direction the 0.6 volt forward characteristic is again displayed.

Back to the Quicktracer. The WC-528A allows us to display on an oscilloscope the collector-base and emitter-base characteristics of a transistor or the anode-cathode characteristic of a diode or Zener diode as was done with the curve tracer. It does not permit a display of a family of characteristics as in Fig. 1, but remember we are trying to determine whether a device is good or bad, not produce its characteristics in detail. Figure 4 is the schematic diagram of the Quicktracer. Resistors R3 and R4 are much higher in value than R2. From the resistance measurements I made along with the comparison of the Quicktracer's and curve tracer's opera-

(continued on page 92)

TELEPHONE INTERCOM



Available with 24 and 36 Switches

The Taskmaster

Put a Taskmaster Telephone communication command post at your desk. Imagine: Push-button call one to 96 individuals. Call by name. No complicated codes or numbers, switchboard or dial selectors. Imagine: Push-button paging over a morale boosting music system. Imagine: A mobile radio system link. Imagine: "No Hands" communications to semi-quiet areas... labs, file rooms, etc. Imagine: Two-way loudspeaking to high noise level areas. Imagine complete privacy with lockout and "camp-on" busy lamp. For the full Taskmaster story, write, wire, or call,

Nelson-Herskfeld Electronics

1848 WEST CAMPBELL AVE. PHOENIX, ARIZONA 85015
PHONE: 602 264 1348

Circle 74 on reader service card

CANADIANS: Ordering is easy — we do the paperwork — try a small order

WESTINGHOUSE ALL TRANSISTOR HOME/OFFICE MESSAGE CENTER

Leaves messages for other for replay... Built in speaker/microphone for talk-into convenience... Records up to 3 minutes of messages... Illuminated signal shows when a message is waiting. Control adjusts playback volume without affecting recording volume. Capstan Drive. BRAND NEW SOLD AS IS \$7.95

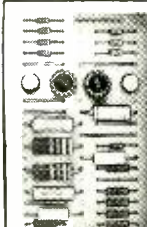

IBM COMPUTER SECTIONS

8 assorted Units we sell for \$1 are loaded with over 150 valuable parts. Incl. — Transistors, Condensers, Resistors, Heat Sinks, Diodes, Etc.

8 for \$1
100 for \$10

SHANNON MYLAR RECORDING TAPE

2 1/2" — 225' .. \$.17	7" — 2400'	\$1.79
3" — 225' .. .19	7" — 3600'	2.95
3" — 300' .. .27	CASSETTE 60 minutes	.69
3 1/4" — 600' .. .58	CASSETTE 90 minutes	1.39
5" — 600' .. .62	CASSETTE 120 minutes	1.97
5" — 900' .. .80	2 1/2" TAPE REEL05
5" — 1200' .. .97	3" TAPE REEL06
5" — 1800' .. 1.49	3 1/4" TAPE REEL07
7" — 1200' .. .77	5" TAPE REEL14
7" — 1800' .. 1.12	7" TAPE REEL15

- WESTINGHOUSE FM TUNER (12DT8 Tube) \$2.99
- WESTINGHOUSE FM TUNER #476-V-015D01 Transistor \$3.99
- 300 — ASSORTED HEX NUTS 2/56, 4/40, 5/40, 8/32, 8/32 .. \$1
- 250 — ASST. SOLDERING LUGS best types and sizes .. \$1
- 250 — ASST. WOOD SCREWS finest popular selection .. \$1
- 250 — ASST. SELF TAPPING SCREWS #8, #8, etc. \$1
- 150 — ASST. 6/32 SCREWS and 150 6/32 HEX NUTS .. \$1
- 150 — ASST. 8/32 SCREWS and 150-8/32 HEX NUTS .. \$1
- 150 — ASST. 2/56 SCREWS and 150-2/56 HEX NUTS .. \$1
- 150 — ASST. 4/40 SCREWS and 150-4/40 HEX NUTS .. \$1
- 150 — ASST. 5/40 SCREWS and 150-5/40 HEX NUTS .. \$1
- 500 — ASSORTED RIVETS most useful selected sizes .. \$1
- 500 — ASSORTED WASHERS most useful selected sizes .. \$1
- 100 — ASST. RUBBER BUMPERS for cabinet bottoms & other uses .. \$1
- 100—ASSORTED RUBBER GROMMETS best sizes .. \$1

RCA 110° FLYBACK TRANSFORMER

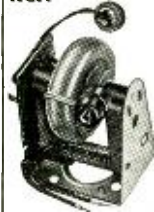

We scooped the Market Latest type — standard for all 110° TV's RCA's design of large Coil produces 18KV — assuring adequate width Incl Schematic Diagram application for any TV List price \$13.90 Your price .. \$3 10% off in lots of 3

- 110° TV DEFLECTION YOKE for all types TV's incl schematic \$3.95
- "COMBINATION SPECIAL" RCA 110° FLYBACK plus 110° DEFLECTION YOKE \$5.95
- 90° FLYBACK TRANSFORMER for all type TV's incl schematic \$2.95
- 90° TV DEFLECTION YOKE for all type TV's incl schematic \$2.95
- 70° FLYBACK TRANSFORMER for all type TV's incl schematic .. \$2
- 70° TV DEFLECTION YOKE for all type TV's incl schematic .. \$2
- 2 — TV CIRCUIT BREAKERS Rated 4.2 TO 5.0 AMPS, etc. .. \$1.19
- 1 — SQ. YARD GRILLE CLOTH Most popular color .. \$2
- 90° COLOR YOKE For all Rectangular 19 to 25" Color CRT's .. \$10.95

- 10 — STANDARD TRANSISTORS NPN & PNP 2N404, 2N414, etc. .. \$1
- 10—ASSORTED DIODE CRYSTALS 1N34, 1N48, 1N60, 1N64, etc. .. \$1
- 3 — TOP BRAND SILICON RECTIFIERS 1 amp, 1000 PIV .. \$1
- COLOR POWER TRANSFORMER — Good for most sets 28R150 List Price—\$36.75 .. \$6.95
- 4—50' HANKS HOOK-UP WIRE assorted colors .. \$1
- 100'—SPOOL SPEAKER WIRE 2 cond, mnl zip, clear, 101 uses \$1.50
- 10 — ASST. RADIO & TV TUBES 456-ke for Transistor Radios .. \$1
- 5 — I.F. COIL TRANSFORMERS 456-ke for Transistor Radios .. \$1
- 5 — AUDIO OUTPUT TRANSFORMERS Sub-min for Trans Radios .. \$1
- TV TWIN LEAD-IN 300 ohm 500' .. \$7 100'—\$1.50 50' — \$1
- CO-AX CABLE RG59U grey or black 250'—\$9 100'—\$3.69 50'—\$2
- 4 — TV ALIGNMENT TOOLS most useful assortment #1 .. \$1
- 4 — TV ALIGNMENT TOOLS For Color TV #2 .. \$1.49
- 6 — TV COLOR ALIGNMENT TOOLS Most popular type .. \$2.79
- 5 — PNP TRANSISTOR general purpose, TO-5 case .. \$1
- 5 — NPN TRANSISTORS general purpose, TO-5 case .. \$1
- UNIVERSAL TV ANTENNA Back of set Mounting .. \$1.98
- 50 — ASSORTED TRANSISTORS big factory scoop—sold as-is .. \$1
- RCA COLOR FLYBACK Part #113382 (Stancor #HG-601C) \$12.95

MARKET SCOOP COLUMN

- 6" UNIVERSAL SPEAKER Top quality Special Buy 5 for \$5 \$1.29 Ea.
- 12" UNIVERSAL SPEAKER Top Quality ... Large Magnet \$4.89
- 10" PHILCO SPEAKER Top Quality ... Large Magnet \$2.99
- 8" UNIVERSAL SPEAKER Large Magnet—Special Buy .. \$2.99
- 5" UNIVERSAL TWEETER 1 Oz. ... Magnet \$1.29
- UNIVERSAL 4" PM SPEAKER Top Quality .. \$1
- 2 1/2" x 4" SPEAKER Special Buy 10 For \$5— 69¢ Ea.
- 3 1/2" — ROUND SPEAKER Special Buy .. 59¢
- 4" X 6" "QUAM" 16 OHM SPEAKER Large magnet ... \$1.79 Special BUY (10 for \$15.00) ..
- CRYSTAL LAPEL MICROPHONE High Imped. 200. 6000 cps .. 11 for \$5 .. 49¢ ea.
- ASTATIC PICKUP MODEL 700-89T Contains 89T ceramic cartridge LIST PRICE \$17.00 ... \$3.95
- 2 — ELECTROLYTIC CONDENSERS ER5 80/50mfd-450V, 20mfd-250V, 150mfd-25V .. \$1
- 2 — ELECTROLYTIC CONDENSERS ER5 200/30/4 mfd — 350V .. \$1
- SPECIAL TUBE BUY (6LJ8-12BH7-12DT8-12SG7-12FX5-1K3) .. 75¢ Ea.
- ALL-AMERICAN TUBE KIT (12AV6-12BE6-12BA6-35W4-50C5) .. \$2.99

Circle 75 on reader service card

Let Bell & Howell Schools help you prepare for a profitable electronic communications business of your own!

Announcing a unique, at-home training program that starts you on your way to a successful business — servicing two-way radio systems for planes ... boats ... fleets of taxis and trucks!



Two-way radio communications is one of the fastest-growing, most lucrative fields in electronics today. Almost two million commercial two-way radio systems now serve as vital communications links for trucks, planes, boats and taxis. And the FCC requires each system to have its equipment serviced regularly by a licensed technician. That's where you come in.

To get ready for a business of your own in two-way radio, you need: 1) career-oriented training; 2) FCC License; 3) "hands on" experience with commercial-grade equipment. Bell & Howell Schools offers a unique new at-home training program that gives you

all three. (See FCC License Guarantee on attached card.)

Find out more about this exciting new Bell & Howell Schools program. There's no obligation.



The new at-home training program that gives you "hands on" experience with \$1,500.00 worth of actual commercial-grade equipment — right in your own home!

Knowing how to put an amateur radio kit together won't help when you're "on the job" —servicing two-way radio systems for aircraft or advising trucking companies about their land-mobile communications system. For that, you need "hands on" experience with the real thing. This new Bell & Howell schools learn-at-home program gives you just that.

Use a genuine commercial band FM transceiver. Test it for frequency, modulation and power output using sensitive professional instruments—right in your own home—as you prepare for a brighter future.

Bell & Howell Schools has helped many thousands of people prepare for careers—and businesses of their own—in electronics. You can have absolute confidence in the training you get.

Expert instructors at Bell & Howell Schools plan each program to answer a single question: "What qualifications will you need to take advantage of *actual career opportunities* in electronics?" They then build each program to give you those exact qualifications.

HERE'S THE EQUIPMENT YOU'LL WORK WITH AT HOME

Commercial-band FM transceiver . . . exactly the kind of two-way radio you'll service throughout your career.

Deviation meter . . . model favored by many working technicians to check modulation of transmitted signal.

Frequency meter . . . highly sensitive instrument used to check signal frequency within precise tolerances established by government standards.



Power output meter . . . meter used almost universally by trained and licensed technicians to check power output—or wattage—of signal.

Alignment generator . . . a custom-designed unit you use to generate test signals for transceiver alignment.

FCC REGULATIONS GIVE YOU THE OPPORTUNITY TO START YOUR OWN BUSINESS

The Federal Communications Commission requires that all commercial two-way communications systems be checked and serviced by a licensed technician at regular intervals.

As a Bell & Howell Schools graduate, you'll have the technical know-how you need. With your FCC license, you can go out and eventually build your own business—signing contracts with companies that use two-way radio. FCC regulations could mean *security and regular income for you!*

BELL & HOWELL SCHOOLS OFFERS YOU THESE SPECIAL ADVANTAGES:

Help Sessions Scheduled regularly every few Saturdays at the Bell & Howell Schools and in many other cities throughout the U.S. and Canada. Top instructors give you personal help and guidance.

Transfer Privileges After completion, you can transfer to any of the resident schools for more advanced study, if you wish.

Lifetime National Placement Service Helps you locate a job any time after you complete your program.

Veterans' Benefits We are approved by the state approval agency for Veterans' Benefits.

Student Financial Aid We are an eligible institution under the Federally Insured Student Loan Program.

EXCLUSIVE ELECTRO-LAB®—YOURS TO KEEP

To make sure you get practical experience with instruments used daily by professionals, we've integrated into your program three precision instrument kits you assemble yourself and keep:

Design Console Use this to rapidly "breadboard" circuits without soldering.

Oscilloscope Offers bright, sharp screen images, 3-way jacks for leads, plugs.

Transistorized Meter Registers current, voltage and resistance.

FOR FULL INFORMATION, MAIL THE ATTACHED CARD TODAY!

DEVRV INSTITUTE OF TECHNOLOGY
ONE OF THE
BELL & HOWELL SCHOOLS

4141 Belmont Avenue, Chicago, Illinois 60641

401

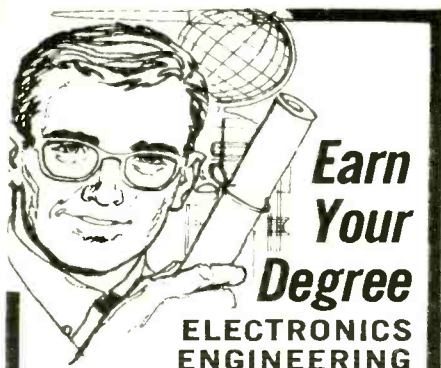

Earn Your Degree

ELECTRONICS ENGINEERING

through HOME STUDY

HIGHLY EFFECTIVE HOME STUDY COURSES IN:

- Electronics Engineering Technology
- Electronics Engineering Mathematics

Earn your Associate in Science Degree in Electronics Engineering and upgrade your status and pay to the engineering level. Complete college level courses in Electronics Engineering. We're a forward looking school. Outstanding lesson material—thorough and easy to understand. Engineering taught on the basis of application and understanding rather than on the basis of memorization. Up to date in every respect. Acquire the knowledge and ability that means the difference between a low paying technician job and a high paying engineering position. Low tuition cost with low monthly payments. Free engineering placement service for our graduates. Write for free descriptive literature. Ask for bulletin R, no salesman will call on you.

COOK'S INSTITUTE
of Electronics Engineering
 Forest Hill Road
 P. O. Box 10634
 Jackson, Miss. 39209
 Established 1945
 Formerly Cook's School of Electronics

Circle 76 on reader service card

TYMETER
 Time At A Glance
 DIGITAL CLOCKS
 Since 1935

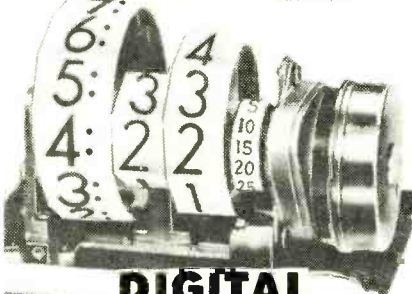
 MADE IN U.S.A.



DIGITAL CLOCK MOVEMENTS

#130... 12 HOUR #131... 24 HOUR
 DIGITS RESETTABLE INDIVIDUALLY
 Available in 50, 60 cy., all voltages, AC. UL approved motor, cord. One Year Guarantee.

#110

SECOND BY SECOND 12 and 24 Hour READ OUT DIGITAL CLOCK
 Complete Line of Count-Up and Count-Down Digital Computers
 CATALOG ON REQUEST

PENNWOOD NUMECHRON CO.
 TYMETER ELECTRONICS
 DIVISION OF LCA CORPORATION
 7249 FRANKSTOWN AVE., PITTSBURGH, PA. 15208

Circle 77 on reader service card

EQUIPMENT REPORT

(continued from page 87)

tion I conclude that R2 is 1000 ohms while R3 and R4 are 240,000-ohm resistors. I measured 12,100 ohms at the plug most of which is R1 the power lim-

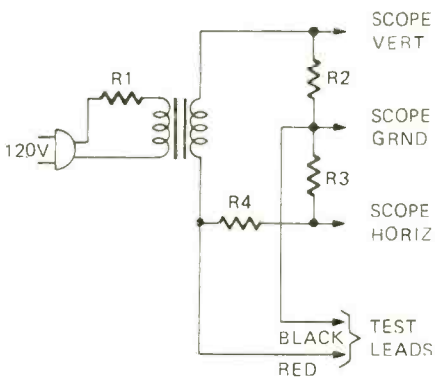

Fig. 4

iting resistor. A portion of the voltage across the device (about half) appears at the horizontal input to the scope while the voltage across the smaller sampling resistor R2 is applied to the scope's vertical input. The vertical movement of the scope beam will correspond to the current through the device connected to the test leads since all current through the tested device flows through R2. A small additional current contributed by R3 and R4 also flows in R2 which will move the trace slightly above the 0 volt horizontal line but is of no consequence. RCA says that power dissipation within any device under test is held below 75 milliwatts. This power limitation is essential to prevent damage to the device being tested. When avalanche breakdown occurs, for example, the current increases rapidly and unlike forward diode conduction, substantial voltage is across the device and substantial power can be dissipated.

After using the WC-528A Quick-tracer for a few days I became convinced that its simplicity of design can really speed solid-state troubleshooting and is an important supplement to the voltage measurement and signal tracing techniques where are usually difficult and time consuming. I recommend that the Quicktrace technique be used first to look for trouble and then followed by more conventional methods if a defective semiconductor cannot be found. The Quicktracer is packaged in a plastic plug-in cube similar to a nickel-cadmium battery charger.

R-E

FREQUENCY METER REPORT
 For an equipment report on another test instrument, this one a frequency meter for CB radio use, go back to page 32. It tells about an instrument more of us should be using.

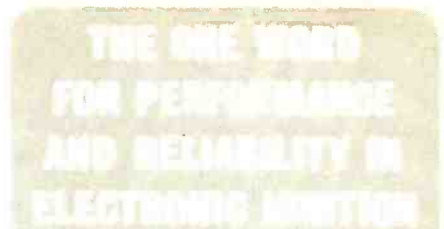

YOU CAN HAVE TOMORROW'S IGNITION ON YOUR CAR TODAY

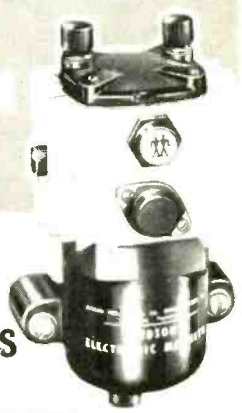

Proven by over 100,000 in operation for over five years.

Don't accept "as good as" there are none.

Write Today for Literature

JUDSON
 RESEARCH AND MFG. CO.
 CONSHOHOCKEN PA. 19428

Circle 78 on reader service card

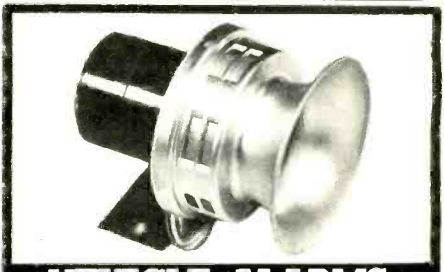

VEHICLE ALARMS and SIRENS

DON'T BE LEFT OFF GUARD WITH LOW QUALITY, HIGH PRICED IMPORTS

Big Name Imports offer **BIG PRICES, SMALL QUALITY.**

U.S.I. offers American Quality and High Efficiency giving YOU no rejects, no returns, and much, much lower costs. If you use 6, 12 or 110 V Sirens or Vehicle Alarm Kits of ANY TYPE, get our prices today—our quality tomorrow. Fail-safe, full proof Protection. Send for Free Catalog today OR Write, Wire or Phone for quantity discounts.

Universal Security Instruments, Inc.

2829 POTEET STREET, BALT. MD. 21231
 (301) 355-9000

"The World's Largest Manufacturer of American Made Vehicle Alarms"

Circle 79 on reader service card

TEST TAPES & RECORDS

(continued from page 26)

equally loud, you have 15 dB of separation, which is adequate. If the test warble is louder, you have less than 15 dB separation, which may not be adequate. If the test warble is lower in volume than the reference, you have more than 15 dB separation.

Another band checks separation right-into-left channel.

An especially ingenious test is the one for cartridge tracking. Two tones, 16,000 Hz and 16,300 Hz, are recorded simultaneously, starting at a low level (low groove velocity, easily tracked) and swooping repeatedly up to a high level, beyond the capability of most pickups to track without distortion. When distortion sets in, you know it because the 300-Hz difference between the two tones becomes distinctly audible. If the duration of the 300-Hz note is short each time the level swoops, the pickup tracks well and intermodulation distortion is low. If the tone is loud and long, the pickup is tracking poorly. The problem may be insufficient stylus force, dirt, stylus wear, or a badly designed or damaged pickup.

Special tests and records

Many other clever and useful tests are included—for example, broadband noise for channel balance and for subjective tests of relative frequency response in left and right channels. None of the tests on Side One of the record require any instruments. But on Side Two, there are comprehensive square-wave and tone-burst tests, intermodulation distortion tests and others that do require instruments and can give precise objective results. The record can be ordered by mail from Ziff-Davis Publishing Co., One Park Ave., New York 10016—\$4.98 postpaid in the USA.

Another useful test record designed exclusively for testing the "trackability" of pickups is Shure's "An Audio Obstacle Course". It's intended largely as a way of demonstrating the claimed superiority of Shure's top-of-the-line pickup, but it is useful and interesting for judging the quality of any pickup. It includes cymbal clashes and other hard-to-track transients, bells, a bass drum, etc., recorded at increasing levels in steps of 4 dB. From it you can learn quickly and well what to listen for in determining the relative quality of any pickup.

It is useful, when troubleshooting a system or shopping for a cartridge, to know how certain kinds of mistracking sound—on musical sounds rather than test tones. You may not always have a test record around.

These are the most interesting tests on the current crop of test records. One additional neat test appears on the Audiotex 30-200 record—a tonearm resonance test. It sweeps smoothly from 50 Hz down to 10 Hz. If at any point during the sweep the level increases, or you hear a buzzing, or the stylus wants to hop out of the groove, there is a severe tonearm resonance at that point.

Test records, like test tapes, need some care to preserve their usefulness. Keep them clean and store them in their wrappers and jackets, upright so they don't warp. Never play a test record with a worn or chipped stylus, or with a tonearm that has more than about 5 or 6 grams stylus force. Many of the tests can be ground into uselessness in one playing with a stylus that digs in too deep.

R-E

**Give Happiness
The United Way**

next month

AUGUST 1972

- Fiber Optics In Electronics
- 11 Ways To Use Your Vectorscope
- Digital Electronic Stopwatch
- Using The VOM and VTVM
- Zirconium Arc Projector
- Bargain Signal Squirter
- Reading Computer
- Sensitive Touch Switch

Designed and manufactured in U.S.A.

NEVER A BURNOUT

IN 4 EMC DIODE-PROTECTED VOMS

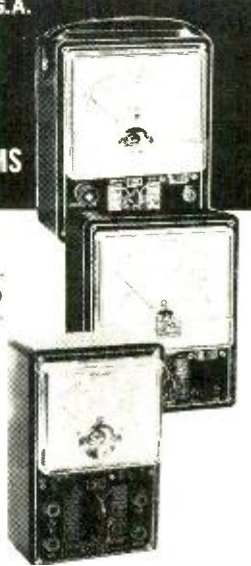

NOBODY ELSE BUT EMC
DESIGNS IN SO MUCH VALUE!

- Professional quality and versatility
- Lifetime protection against electrical abuse
- No meter burnout, needle damage, or fuse replacement

VOLOMETER
Model 109A Factory Wired & Tested \$29.95
Model 109AK Easy-to-Assemble Kit \$21.65
 20,000 Ω/v DC sens, 10,000 Ω/v AC sens.
 4½", 40 μ a meter. High impact bakelite case.
 5 DC voltage ranges: 0-6-60-300-600-3000v.
 5 AC voltage ranges: 0-12-120-600-1200-3000v.
 3 DC current ranges: 0-6-60-600ma.
 3 AC current ranges: 0-30-300ma; 0-3A.
 3 resistance ranges: 0-20K, -200K, -20 megs.
 5 db ranges: -4 to +67db. With carrying strap. 5¼" W x 6¾" H x 2⅞" D.

POCKET SIZE VOLOMETER
Model 102A
 Factory Wired & Tested \$17.95
Model 102AK
 Easy-to-Assemble Kits \$14.95
 3½", 2% accurate 800 μ a D'Arsonval type meter. One zero adj. for both res. ranges. High impact bakelite case. 5 AC voltage ranges: 0-12-120-600-1200-3000v. 5 DC voltage ranges: 0-6-60-300-600-3000v. 3 AC current ranges: 0-30-150-600ma. 4 DC current ranges: 0-6-30-130ma; 0-1.2A. Resistance: 0-1K, 0-1 meg. 3¼" W x 6¼" H x 2" D.

Send FREE catalog of complete EMC line and name of nearest distributor.

RE-7

Name _____
 Address _____
 City _____
 State _____ Zip _____

EMC
 ELECTRONIC MEASUREMENTS CORP.
 625 Broadway, New York, N.Y. 10012

DESIGNS OF THE NEW SHAPE OF SOUND TOMORROW

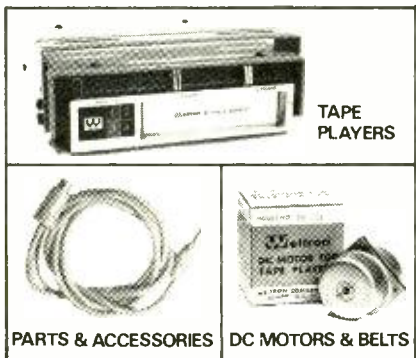

COMPLETE CATALOG AVAILABLE.
CALL YOUR WELTRON DISTRIBUTOR TODAY!
or write or call direct.



Circle 80 on reader service card

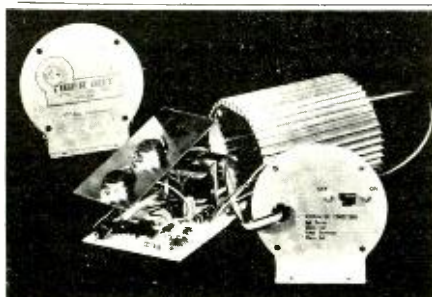

FROM KIT TO CAR IN 80 MINUTES!

Electronic ignition is "in". Update your car with the TOPS in power, efficiency and reliability — the TIGER SST capacitive discharge ignition (CD).

The TIGER delivers everything other CD's promise — and more: quicker starting, more power, more gas mileage, tune-ups eliminated lifetime plugs and points, reduced repairs and pollution.

The TIGER can be built and installed in your car in 80 minutes. The TIGER is unique! Errors in construction or incorrect installation will not harm the TIGER or the engine. The TIGER will not operate under either condition.

The TIGER comes with a switch for TIGER or standard ignition for 12V negative ground only.

SATISFACTION GUARANTEED
or Money Back.

Simpli-Kit \$29.95 — Assembled \$39.95
POST PAID

Send check or money order with order to:

Tri-Star Corporation

DEPT. R, P. O. Box 1946
Grand Junction, Colorado 81501

Circle 81 on reader service card

94 RADIO-ELECTRONICS • JULY 1972

BREADBOARD DIGITAL CIRCUITS

(continued from page 61)

Now set the sliders for the four program inputs, P1, P2, P3, and P4 (sliders for pins 2, 4, 6, and 7, respectively) to the combination of logic 0 and logic 1 inputs selected from the following programming table for the desired divisor:

To divide by	Settings			
N =	P1	P2	P3	P4
2	1	1	1	0
3	1	1	0	0
4	1	0	0	0
5	0	0	0	1
6	0	0	1	0
7	0	1	0	0
8	1	0	0	1
9	0	0	1	1
10	0	1	1	0
11	1	1	0	1
12	1	0	1	0
13	0	1	0	1
14	1	0	1	1
15	0	1	1	1

Move the slider for pin 16 (preset) to position 2, then back to position 1, to enter the program. The circuit will produce one output pulse for every N input pulses.

Now that you've become proficient in programming and know how to use the matrix switch effectively, you should be able to devise and breadboard many circuits of your own, based on the increasing variety of integrated circuits on the market today. A number of them contain a multiplicity of circuits on a single chip, that can be patched together in relatively short order. A quick scan through any digital IC manual should reveal many interesting circuits, some of which perform very complex numerical manipulations. R-E

The Digi-Dyna-Check has literally taken off since the first article in this series appeared in the May issue. Many of you were stymied the first month because we neglected to tell you where to obtain the most essential parts. The great demand has necessitated some changes in the kit make-up as described last month. Here is the listing of kits and their sources:

The following kits of parts are available from The Electronics Co., Inc., P.O. Box 278, Cranbury, N. J. 08512.

DDC-2, a revised programming manual listing more than 500 commonly used digital integrated-circuit devices with their pin-connection diagrams is available for \$2.75.

DDC-3, a kit containing the integrated circuits used in these experiments (one each SN7400, SN7493 and DM8520) is available for \$6.95 including postage and insurance.

A complete kit of all parts for building the Digi-Dyna-Check, including an improved power supply, LED lamps, programming and assembly manual and a case are available for \$79.50 from MITS Corp., 2016 San Mateo Avenue N.E., Albuquerque, New Mexico 87110.



QUIET
ZONE
SILENCE
WANT TO KEEP
THINGS QUIET?
AND
CLEAN
TOO?

Then use Quietrole... the choice of better servicemen everywhere for cleaning and lubricating all T.V. moving parts.

Spray Pack guarantees silent, smooth operation, with absolutely no harmful aftereffects for both color, and black and white sets.

Also available in bottles if you prefer.



Circle 82 on reader service card

ANOTHER SUPERB
VALUE
from **Olson**
Electronics



ONLY

\$25

DELUXE
STEREOPHONES

A new sound sensation is yours to enjoy with this extra lightweight headphone that offers superb wide range response, fatigue-free listening, soft air-filled cushions and adjustable headband. Works fine with any music system. 20' cord has standard 1/4" stereo plug attached.

Olson Electronics, Dept. L7
260 S. Forge St., Akron, Ohio 44308

I enclose \$25 plus \$1 for postage and handling. Send me the PH-173 Stereophones.

Send me the next seven issues of the Olson Catalog, without cost or obligation. **FREE**

Name _____

Address _____

City _____

State _____ Zip _____

Circle 83 on reader service card

IMPOSSIBLE? BARGAINS IN SURPLUS ELECTRONICS AND OPTICS

FEATURE ITEM

50 MEGAHERTZ LOW COST COUNTER



Here is a new item, featured because of numerous customer suggestions.

We have taken the basic power supply, chassis and cover from our clock kit, and by substituting a new front panel and printed circuit board, have made a

lowest cost frequency counter. The unbelievable low cost is due to our use of our large stock of unused surplus nixies, the new 74196 50 MHz decade counter, and the commonality of parts with our other kits. Readout is to six decades, time base is 1 second, 0.1 seconds, or external. Design is modular, for ease of construction, compactness, and expandability.

- 50 MHz six digit counter, using line frequency as time base, complete except for cover . . . \$97.50
- Optional crystal controlled time base plug-in conversion . . . \$23.50
- Cover, blue or black anodized . . . \$ 4.50

NICKEL CADMIUM RECHARGEABLE BATTERIES



These batteries are the type used in electronic flash units, electric knives, toothbrushes, etc. They are rated at 6 volts, 0.080 ampere hours. They are of sealed construction, and may be operated in any position.

- Brand New Rechargeable Battery . . . \$2.50
- Used, Fully Checked Out . . . \$1.50

BUILD YOUR OWN ELECTRONIC CALCULATOR FOR ONLY \$108.00!



A complete calculator kit, complete with self contained power supply and case. Indispensable in the home, office or school. Simple enough for a child to build. Some of the features of the calculator are as follows:

- MOS integrated circuits (extra large scale integration) reduce the number of components to a minimum, for easy assembly
- Displays eight digits on large size seven segment displays.
- Full function complement keyboard features addition, subtraction, multiplication, division, alternate display, multiplication by a

constant, clear all, clear entry, and decimal point set. • Sixteen digit entry and sixteen digit results are possible with alternate display key. • Leading zeroes suppressed • Chain operation • All integrated circuits and displays are socket mounted and replaceable.

So reliable and simple to build, we can make this guarantee: If for any reason you cannot succeed in getting your calculator to function properly after completing construction, for a flat handling fee of \$10.00, B and F will repair and ship back your calculator anywhere in the USA. This applies regardless of the age of the assembler, barring gross negligence or the use of acid core solder in construction.

SANYO CALCULATOR, MODEL ICC 804



This calculator with L.E.D. readout and rechargeable self-contained nickel cadmium battery was advertised in our March ad at \$215.00 (if you ordered it at the higher price we will refund you the difference in merchandise on request). Due to a special purchase, we can now offer this \$299.00 list calculator at only \$175.00, making it the outstanding calculator buy in the USA. Comes complete with charger/power supply and case. Has eight digit display, with 16 digit capacity. Unit is only 1 1/2" thick, easily slips in pocket. You can charge it by phone to BankAmericard or Mastercharge.

Sanyo Calculator . . . \$175.00

- SHRINK TUBING SPECIAL. Assortment of 200 pieces of shrink tubing, diameters 1/8" to 1/2", length 1/2" to 2" . . . \$1.25

KEYBOARDS

Three keyboards are available, as illustrated. 20 key calculator keyboard, 40 key alphanumeric, and 12 key touch tone. All have separate contacts brought out to edge connector.



- Touch Tone Keyboard . . . \$ 9.50
- Calculator Keyboard . . . \$14.50
- Alphanumeric Keyboard . . . \$29.00

LIGHT EMITTING DIODE



This display is excellent for small portable electronics, such as DVM's, calculators, etc. Equivalent to Monsanto MAN 3A. Operates from 5 volts, 20 milliamperes, with 47 ohm dropping resistor.

- 3.25 each . . . \$3.95 each
- 10 for 27.50 . . . \$35.00
- Complete counter kit, 7490, 7475 latch 7447, printed circuit board, led readout . . . \$9.50

Last minute special!!!
Extra large size MAN 3A
\$4.50 each, 10 for \$40.00

RADIATION METER ("Geiger Counter")



You can buy a complete radiation meter, complete with original instruction books, at less than the price of the meter movement alone. Range is 0.02 to 50 Roentgens/hour. This is not sensitive enough for prospecting, but useful for other radiation measuring and monitoring purposes. If not used for its original function, then the case, meter and battery holder alone are worth our asking price as a basis for building a metal locator, etc. Uses standard D cell and 22.5 volt Battery.

- Radiation Meter . . . \$9.50 + \$1.00 postage & handling

DIGITAL CLOCK KIT WITH NIXIE DISPLAY



We have well over 20,000 surplus nixies in stock, and because of this bargain purchase we can sell a complete digital clock kit for less than the usual cost of the display tubes only. We provide

a complete etched and thru-plated circuit board, all integrated circuits, complete power supply, display tubes, I.C. sockets and a nice front panel with polaroid visor. We have never seen anyone offer this kit for less than \$100.00 before. Includes BCD outputs for use as with timer option. May be wired for 12 or 24 hour display. Indicates hours, minutes, seconds.

- Clock Kit, complete less outside cover . . . \$57.50
- Aluminum blue or black anodized cover (specify) . . . \$ 4.50

READOUT SPECIALS

- Low current readout, in dual-in-line package. Plugs into 16 pin integrated circuit socket. Ideal for miniature battery powered instruments current is 8 milliamperes at 5 volts. Life is rated at 250,000 hours. Works fine from 7447 decoder Driver. . . \$3.25 each, 4 for \$11.00



- Complete counter kit, above readout with 7490 decade counter, 7447 decoder-driver and etched printed circuit board. . . \$8.00 each.



- Extra large size readout, in glass envelope package with wire leads, draws 20 milliamperes at 5 volts, works from 7447 driver, 100,000 hours rated life. . . \$3.50 each, 4 for \$12.00

- Counter kit, 7490, 7447, P.C. board as above . . . \$8.50 each.

- On either of above kits, add \$2.00 for, 74192 Up/Down counter option, \$1.50 for 7475 latch.

MOLEX SOLDERCON CONNECTIONS



Molex soldercon connections for I.C.'s. With these you can build low cost I.C. sockets by just cutting off the number of connections required, i.e., two strips of seven for 14 pin socket.

- 500 Molex soldercon . . . \$ 4.75

TRANSFORMER SPECIALS

- Stancor P6378, 24 volts at 4 amps, 12 or 6 volts at 8 amps, include shipping for 5 lbs. . . \$ 7.50
- Dektronic, designed for Sanken amplifiers, 48 or 62 volts D.C. at 2 amperes, include shipping for 5 lbs. . . \$ 7.50
- 17 volts center tapped at 3.25 amperes plus 170 volts at .050 amperes. Makes excellent supply for TTL logic and Nixie or Sperry readouts, include shipping for 5 lbs. . . \$ 7.50

Circle 84 on reader service card

SANKEN HYBRID AUDIO AMPLIFIERS AND SUPPLY KIT



We have made a fortunate purchase of Sanken Audio Amplifier Hybrid Modules. With these you can build your own audio amplifiers at less than the price of discrete components. Just add a power supply, and a chassis to act as a heat sink. Brand new units, in original boxes, guaranteed by B and F, Sanken and the Sanken U.S. distributor. Available in three

sizes: 10 watts RMS (20 watts music power), 25 watts RMS (50 watts M.P.), and 50 watts RMS (100 watts M.P.) per channel. 20 page manufacturers instruction book included. Sanken amplifiers have proved so simple and reliable, that they are being used for industrial applications, such as servo amplifiers and wide band laboratory amplifiers.

- 10 Watt RMS Amplifier . . . \$ 4.75
- 25 Watt RMS Amplifier . . . \$14.75
- 50 Watt RMS Amplifier . . . \$22.50
- Complete kit for 100 watt rms stereo amplifier (200 watt music) including two 50 watt Sanken hybrids, all parts, instructions, and nice 1/16" thick black anodized and punched chassis . . . \$88.00
- Same for 50 watt rms stereo amplifier includes two 25 watt Sankens, etc. . . \$58.00
- Same for 20 watt rms stereo, includes two 10 watt Sankens, etc. . . \$30.00

INTEGRATED CIRCUIT SPECIALS

- 705 Operational Amplifier \$50
- 711 Dual Comparator \$50
- 741 Compensated Operational Amplifier \$50
- 558 Dual 741 \$95
- 723 Voltage Regulator \$1.25
- 536 F.E.T. Operational Amplifier \$4.75
- 595 Four Quadran Multiplier \$3.75
- 740 Power Driver, for 100 watt AB amplifier \$2.75
- 2111 FM Detector and Limiter \$2.75
- 555 Timer 2 μSeconds to 1 hour, Special! \$1.25
- 1103 1024 Bit Ram Memory, MOS \$9.25
- 2501 256 Bit Ram Memory, MOS \$8.75
- 2513 Character Generator ROM \$19.75
- 7490 Decade Counter \$1.25
- 74141/7441 Nixie Driver \$1.75
- 74192 Bidirectional Counter \$1.75
- 7475 Quad Latch \$1.25
- 7447 7 Segment Decoder Driver \$2.25
- 7489 64 Bit Random Access Memory \$5.75
- 7492 Divide by 12 Counter \$1.25
- 74196 50 MHz Divide by 10 Counter (presetable) \$2.25
- NE560 Phase Locked Loop \$5.00
- 561 Phase Locked Loop \$5.00
- 562 Phase Locked Loop \$5.00
- 565 Phase Locked Loop \$5.00
- 566 Function Generator/Tone Encoder \$5.00
- 567 PLL/Tone Decoder \$5.00

We will match or better any 7400 Series I.C. price. Our listing of this series is too long to publish here, we stock over 150 different numbers. Call and charge to Mastercharge/BankAmericard or write for special price list on this series.

SANKEN HIGH POWER, HIGH PERFORMANCE HYBRID VOLTAGE REGULATORS



These hybrid regulators are easy to use, requiring no external components. Excellent for operational amplifier supplies, logic supplies and other high performance applications. All regulators have less than 50 millivolts ripple and better than 1% line and load regulation, some models far exceeding this specification.

- SI3120E 12 Volts 1 Ampere \$2.25
- SI3150E 15 Volts 1 Ampere \$2.25
- SI3240E 24 Volts 1 Ampere \$2.25
- SI3050E 5 Volts 1 Ampere \$2.25
- SI3554M 5 Volts 3 Amperes \$7.00

80 PAGE CATALOG - Free with any order or send \$0.25

To our customers:

B and F is moving to a new location: 119 Foster Street, Peabody, Mass. 01960 (same address, but different building). Our apologies to any customers who experienced delays in shipments during the move. Our new expanded shipping and storage areas will allow us to service your order faster than ever before. Retail customers are now welcome at all working hours (Monday through Friday, 9 - 5, Saturday, 9 - 3). Special few of a kind items are being cleared out, so come and visit our new location with twenty five thousand square feet of surplus bargains.

ALL ITEMS (WHERE WEIGHT IS NOT SPECIFIED) POSTAGE PAID IN THE U. S. A.

CHARGES WELCOME!

Phone in charges to 617 531-5774 or 617 532-2323. BankAmericard -- Mastercharge. \$10.00 minimum. No C.O.D.'s please.

B. & F. ENTERPRISES

Phone (617) 532-2323

P.O. Box 44, Hathorne, Massachusetts 01937

THEY SPEAK YOUR LANGUAGE

USER NOTES



User Notes is an application note series on the latest linear and digital IC's, and construction projects like the Digital Multimeter and Calculator kits. This series is obtainable only through annual subscription and contains circuits never published elsewhere. Thousands of beginning and advanced hobbyists have found the series informative and stimulating. Below is a partial list of current topics. Subscribe now and get all the back issues, FREE.

- UN312 CALCULATOR CIRCUIT
- 10 DIGIT
- UN313 TTL DESIGN GUIDE
- UN317 DECIMAL COUNTING &
7-SEGMENT DISPLAYS
- UN319 THE 741 OPERATIONAL
AMPLIFIER
- UN324 INTERFACING RTL WITH
TTL AND DTL LOGIC
- UN326 DUAL OUTPUT TRACK-
ING OP-AMP POWER
SUPPLY
- UN329 ELECTRONIC DICE
GAME
- UN330 HIGH ACCURACY LOW
COST DIGITAL MULTI-
METER
- UN334 DRIVING AND SENSING
CORE MEMORIES
- UN338 DIGITAL STOP WATCH
CIRCUITRY
- UN339 A 12-HOUR DIGITAL
CLOCK
- UN347 AUTOMATIC TELE-
PHONE DIALER

Mailed four-times per year. Subscription rates \$5 annually for the US except Alaska and Hawaii which is \$6. Canada and Mexico \$6. All other countries \$7.50.

epd ENVIRONMENTAL PRODUCTS
BOX 1014 Greenwood Springs, CO 81601

market center

PLANS AND KITS

FREE catalog of the most unusual electronic kits available. Electronic music accessories, Surf and Wind Synthesizers, electronic Wind Chimes, many others. **PAIA ELECTRONICS**, Box B14359, Oklahoma City, OK 73114

PORTABLE Digital Volt-Ohmmeter Kit Compact (8x5x3) size, Pushbutton Ranging Battery or A.C. Operation. Write **AZ-TECH. LABS**, P.O. Box 1281, Minnetonka, Minn. 55343

UNIQUE THREE-CHANNEL COLOR ORGAN Features: independent channel control, unaffected by changes in output volume control, 300 watts per channel, high input impedance. Complete plans and instructions available for \$1.00 from **H & R ELECTRONICS**, Box 134, Annapolis Jct., Md. 20701

ELECTRONIC ORGAN KITS, keyboards, oscillator coils and other components for organ building. 25¢ for catalog. **DEVTRONIX ORGAN PRODUCTS**, 5872 Amapola Dr., San Jose, Ca. 95129

FREE BROCHURE. ALL NEW WAY TO FASTER, BETTER CIRCUIT DEVELOPMENT AND DIGITAL LOGIC DESIGN. IN KIT OR ASSEMBLED FORM. **EXCELTECH, INC.**, BOX 17056, San Diego, Ca. 92117

BUILD your own **TELEPHONE ANSWERING SERVICE**. Detailed plans \$3.90. Save money. Don't miss another call. **TONSCOPE**, 400 Third Ave., Satellite Beach, Fla. 32937

CONVERT any television to sensitive big-screen oscilloscope. Only minor changes required. No electronic experience necessary. Illustrated plans \$2.00. **RELCO-A25**, Box 10563, Houston, Tx. 77018

CLASSIFIED COMMERCIAL RATE (for firms or individuals offering commercial products or services). 90¢ per word . . . minimum 10 words.

NONCOMMERCIAL RATE (for individuals who want to buy or sell personal items) 60¢ per word . . . no minimum.

FIRST WORD and **NAME** set in bold caps at no extra charge. Additional bold face at 10¢ per word. Payment must accompany all ads except those placed by accredited advertising agencies. 10% discount on 12 consecutive insertions, if paid in advance. Misleading or objectionable ads not accepted. Copy for September issue must reach us before June 30.

CLASSIFIED ADVERTISING ORDER FORM

1	2	3	4	5
6	7	8	9	10
11	12	13	14	15
16	17	18	19	20
21	22	23	24	25
26	27	28	29	30
31	32	33	34	35

No. of Words { @ .60 Non-Commercial Rates } = \$ _____
 { @ .90 Commercial Rate } = \$ _____
 No. of Words in bold caps @ .10 = \$ _____

Total Enclosed \$\$ _____

Insert _____ time(s)

Starting with _____ issue

Payment must accompany order unless placed through accredited advertising agency 28

NAME _____

ADDRESS _____

CITY _____ STATE _____ ZIP _____

SIGNATURE _____

MAIL TO: RADIO-ELECTRONICS, CLASSIFIED AD DEPT., 200 PARK AVE. SOUTH, NEW YORK, N.Y. 10003

LOWEST PRICES: ON BRAND NEW FULLY TESTED & GUARANTEED IC'S
BEST SERVICE: 10% DISCOUNT ON ALL ITEMS NOT SHIPPED IN 24 HOURS
MOST CONVENIENT: ORDER DESK 1-800-325-2595 (TOLL FREE)

PLEASE NOTE: To qualify for prices in the last three columns, you must order in EXACT Multiples of 10 per item for all IC items on your order.

Catalog Number	ANY QUANTITY PER ITEM(MIX)			MULTIPLES OF 10 PER ITEM(MIX)			Catalog Number	ANY QUANTITY PER ITEM(MIX)			MULTIPLES OF 10 PER ITEM(MIX)		
	1-99	100-999	1000-up	100-999	1000-9990	10000-up		1-99	100-999	1000-up	100-999	1000-9990	10000-up
7400	.26	.25	.23	.22	.21	.20	74122	.70	.67	.63	.60	.56	.53
7401	.26	.25	.23	.22	.21	.20	74123	1.21	1.06	1.00	.94	.89	.83
7402	.26	.25	.23	.22	.21	.20	74141	1.63	1.55	1.46	1.38	1.29	1.20
7403	.26	.25	.23	.22	.21	.20	74145	1.41	1.33	1.26	1.18	1.11	1.04
7404	.28	.27	.25	.24	.22	.21	74150	1.63	1.55	1.46	1.38	1.29	1.20
7405	.28	.27	.25	.24	.22	.21	74151	1.20	1.13	1.07	1.01	.95	.88
7406	.52	.50	.47	.44	.42	.39	74153	1.63	1.55	1.46	1.38	1.29	1.20
7407	.52	.50	.47	.44	.42	.39	74154	2.43	2.30	2.16	2.03	1.89	1.08
7408	.32	.30	.29	.27	.26	.24	74155	1.46	1.39	1.31	1.23	1.16	1.08
7409	.32	.30	.29	.27	.26	.24	74156	1.46	1.39	1.31	1.23	1.16	1.08
7410	.26	.25	.23	.22	.21	.20	74157	1.56	1.48	1.39	1.31	1.23	1.15
7411	.28	.27	.25	.24	.22	.21	74158	1.56	1.48	1.39	1.31	1.23	1.15
7413	.58	.55	.52	.49	.46	.44	74160	1.89	1.79	1.68	1.58	1.47	1.37
7416	.52	.50	.47	.44	.42	.39	74161	1.89	1.79	1.68	1.58	1.47	1.37
7417	.52	.50	.47	.44	.42	.39	74162	1.89	1.79	1.68	1.58	1.47	1.37
7420	.26	.25	.23	.22	.21	.20	74163	1.89	1.79	1.68	1.58	1.47	1.37
7421	.26	.25	.23	.22	.21	.20	74180	1.20	1.13	1.07	1.01	.95	.88
7426	.34	.32	.31	.29	.27	.26	74181	5.20	4.90	4.59	4.23	3.98	3.67
7430	.26	.25	.23	.22	.21	.20	74182	1.20	1.13	1.07	1.01	.95	.88
7437	.56	.53	.50	.48	.45	.42	74192	1.98	1.87	1.76	1.65	1.54	1.43
7438	.56	.53	.50	.48	.45	.42	74193	1.98	1.87	1.76	1.65	1.54	1.43
7440	.26	.25	.23	.22	.21	.20	74198	2.81	2.65	2.50	2.34	2.18	2.03
7441	1.73	1.64	1.55	1.46	1.37	1.27	74199	2.81	2.65	2.50	2.34	2.18	2.03
7442	1.27	1.21	1.14	1.07	1.01	.94	NE501	2.99	2.82	2.66	2.49	2.32	2.16
7443	1.27	1.21	1.14	1.07	1.01	.94	NE531	3.81	3.58	3.36	3.14	2.91	2.69
7444	1.27	1.21	1.14	1.07	1.01	.94	NE533	3.81	3.58	3.36	3.14	2.91	2.69
7445	1.71	1.62	1.53	1.44	1.35	1.26	NE535	7.31	6.88	6.45	6.02	5.59	5.16
7446	1.24	1.17	1.11	1.04	.98	.91	NE540	2.16	2.04	1.92	1.80	1.68	1.56
7447	1.16	1.10	1.04	.98	.92	.85	NE550	1.24	1.17	1.11	1.04	.98	.91
7448	1.44	1.37	1.29	1.22	1.14	1.06	NE551	3.57	3.36	3.15	2.94	2.73	2.52
7450	.26	.25	.23	.22	.21	.20	NE561	3.57	3.36	3.15	2.94	2.73	2.52
7451	.26	.25	.23	.22	.21	.20	NE562	3.57	3.36	3.15	2.94	2.73	2.52
7453	.26	.25	.23	.22	.21	.20	NE565	3.57	3.36	3.15	2.94	2.73	2.52
7454	.26	.25	.23	.22	.21	.20	NE566	3.57	3.36	3.15	2.94	2.73	2.52
7460	.26	.25	.23	.22	.21	.20	NE567	3.57	3.36	3.15	2.94	2.73	2.52
7470	.42	.40	.38	.36	.34	.32	NE5111	.90	.86	.81	.77	.72	.68
7472	.38	.36	.34	.32	.30	.29	NE5556	1.87	1.77	1.66	1.56	1.46	1.35
7473	.50	.48	.45	.43	.40	.38	NE5558	.80	.76	.72	.68	.64	.60
7474	.50	.48	.45	.43	.40	.38	NE5595	3.40	3.20	3.00	2.80	2.60	2.40
7475	.80	.76	.72	.68	.64	.60	NE5596	1.87	1.77	1.66	1.56	1.46	1.35
7476	.56	.53	.50	.48	.45	.42	709	.42	.40	.38	.36	.34	.32
7480	.76	.72	.68	.65	.61	.57	710	.42	.40	.38	.36	.34	.32
7483	1.63	1.55	1.46	1.38	1.29	1.20	711	.44	.42	.40	.37	.35	.33
7486	.58	.55	.52	.49	.46	.44	723	1.00	.95	.90	.85	.80	.75
7489	4.25	4.00	3.75	3.50	3.25	3.00	741	.44	.42	.40	.37	.35	.33
7490	.80	.76	.72	.68	.64	.60	748	.48	.46	.43	.41	.38	.36
7491	1.43	1.35	1.28	1.20	1.13	1.05	1M270	.15	.14	.13	.12	.11	.10
7492	.80	.76	.72	.68	.64	.60	1M751A	.30	.28	.26	.24	.22	.20
7493	.80	.76	.72	.68	.64	.60	1M914	.10	.09	.08	.07	.06	.05
7494	1.18	1.12	1.05	.99	.93	.87	1M4002	.15	.14	.13	.12	.11	.10
7495	1.18	1.12	1.05	.99	.93	.87	1M4154	.15	.14	.13	.12	.11	.10
7496	1.18	1.12	1.05	.99	.93	.87	2M3860	.25	.23	.21	.19	.17	.15
74100	1.52	1.44	1.36	1.28	1.29	1.12							
74107	.52	.49	.47	.44	.42	.39							
74121	.56	.53	.50	.48	.45	.42							

All IC's that we supply in 8-, 14-, 16-, or 24-pin DIP (Dual-in-Line) plastic package, except for NE536, NE537, NE540, and SE540 which come in TO-5 package. We give FREE data sheets upon request, so ask for those data sheets that you NEED, even for those listed IC's that you are not buying. On orders over \$25.00 we'll send you a new 270-page COMPLETE TTL IC data book FREE. Or, you may obtain a new 240-page LINEAR data book instead. Orders over \$50.00 will receive both books. Orders over \$100.00 will receive a complete LIBRARY of DIGITAL & LINEAR data & application books totaling 1000 pages FREE. PLEASE NOTE: Data books are shipped separate from your order. Please allow two weeks for delivery.

UNIVERSAL DECADE COUNTING UNITS

- Easy to read single plane LED or Filament-type Readout with wide angle viewing.
- BCD Outputs available
- Readout Lamp Test
- Selectable Ripple Blanking
- Selectable Decimal Point
- Counter Reset
- Plug-In Module
- Molex sockets for all IC's & Readout
- Tin-Plated G-10, 4-oz Copper, Glass Epoxy Board
- Your choice of 1 to 6 decades on one P.C. board.
- Grouping of 2 or more readouts on the same card, for custom designed appearance.
- 5-Volt TTL compatible single supply.
- First in a series of universal plug-in modules to be introduced soon: for frequency counting, time measurements, event counting, DVM, magnitude comparison, etc.
- Well documented application note with step-by-step assembly and hook-up instructions.



Price (Per Decade):

Basic Unit consisting of 7490, 7447, Filament-type 7-segment Readout....\$8.00

Options:

- For LED Readouts instead of Filament-type add \$2.00
- For 7475 Latch add...\$1.25
- For 74176 instead of 7490 add.....\$0.50
- For 74192 instead of 7490 add.....\$1.00
- For 74196 instead of 7490 add.....\$0.75
- For Fully assembled and tested unit add.....\$2.50



LED 7-SEGMENT DISPLAY

\$4.95 Each

50-99 \$4.75
100-999 \$4.50
1000-up \$4.25

Large 1/2" 7-segment LED readout similar to the popular MAN-1 but with improved brightness. Has left-hand decimal point. Fits in a DIP socket. Expected life: Over 100 Yrs. Regularly \$12.95 in single lots. These are BRAND NEW with full data sheet and 4-page MULTIPLEXING Application Note. Needs a 7447 for driver and ONE CURRENT-LIMITING RESISTOR PER SEGMENT. We can supply you with one or ten thousand FROM STOCK. Also available, ±1 OVERFLOW digit at the same prices. Mixing of Regular & Overflow digit allowed.

Package of 8, 47Ω, 1/4W limiting R's.....30¢

Incandescent Type of 7-segment display. With right-hand decimal point. Rated 8mA per segment at TTL supply of 5V. Design life of 50,000 hours. Needs a 7447 as a driver. In DIP Package. Each \$3.25



MOLEX IC SOCKET PINS: Use these economical pins instead of soldering your IC's to PC boards. Sold in continuous strips in multiples of 100 pins only.



100 for \$1.00; 200 for \$1.80; 300 for \$2.60
400 for \$3.40; 500 for \$4.20; 600 for \$5.00
700 for \$5.80; 800 for \$6.60; 900 for \$7.40
1000 for \$8.20. Each additional 1000 \$7.50

ALLEN-BRADLEY MIL-GRADE (5-BAND) RESISTORS. Any of the 84 STANDARD 10% values from 2.7Ω to 22MΩ, 1/4 or 1/2 WATT. EACH.....5¢

CERAMIC DISC CAPACITORS. Type 5GA-1000WVDC. 5, 7.5, 10, 12, 15, 20, 22, 25, 27, 30, 33, 39, 50, 56, 68, 75, 82, 100, 120, 150, 180, 200, 220, 250, 270, 300, 330, 360, 390, 470, 500, 560, 680, 750, 820, 1000, 1200, 1500, 1800, 2000, 2200, 2500, 2700, 3000, 3300, 3900, 4700, 5000µF. EACH.....10¢
0.01µF. Each.....11¢ 0.02µF. EACH.....12¢

LOW VOLTAGE DISCS, Type UK.
1.0 µF, 3V.....25¢ 2.2 µF, 3V.....30¢
0.1 µF, 10V.....12¢ 0.2 µF, 10V.....20¢
0.47µF, 3V.....25¢ 0.01µF, 16V.....10¢

ELECTROLYTIC CAPACITORS: All values are available in both, axial or upright (PC Board) mount. PLEASE INDICATE YOUR CHOICE.
10 µF, 15V.....15¢ 100 µF, 25V.....25¢
500 µF, 25V.....30¢ 1000 µF, 35V.....50¢

VOLTAGE REGULATORS. Internally-set, overload and short-circuit proof regulators need no external components to set. With data sheet and application notes. TO-3 Package.
LM-335, 5V, 600mA.....\$2.85
LM-336, 12V, 500mA.....\$3.85
LM-337, 15V, 450mA.....\$4.05
20 Watt PC-Board Type HEAT SINK.....\$1.20

STANCOR P-8180, 25.2 VCT, 1-Amp Transformer. Ideal for use with LM-series. Each....\$3.00



SOLID STATE SYSTEMS, INC.
P. O. BOX 773
COLUMBIA, MO. 65201
PHONE 314-443-3673
TWX 910-760-1453



TERMS: RATED FIRMS NET 30 DAYS. Others CHECK or MONEY ORDER with order. Add 35¢ to orders under \$5.00 for postage & handling. For UPS add 45¢ and for AIR MAIL add 65¢ to your order; we pay the balance. If you are served by UPS in your area, we strongly recommend this service with its built-in \$100 insurance. COD orders are FOB Columbia with 65¢ COD fee additional. Canadian residents please add 50¢ for INSURANCE.

MISSOURI RESIDENTS: Please add 4% Sales Tax. WRITE OR CIRCLE READER SERVICE CARD FOR OUR CATALOG OF PARTS & SERVICES. IT'S FREE.

Circle 89 on reader service card

1972 SUMMER SALE

CALCULATOR CHIP

40 DIP "calculator on a chip" the manufacturer will not let us advertise the number of this item but we provide full data and instructions for building a 12 digit calculator... \$14.95 each

FOLLOWING ITEMS IN LIMITED QUANTITY

LM103 regulator diode TO-18	\$.50
LM308 micropower op amp TO-5	1.25
75451 dual peripheral driver 8 pin DIP	.75
NE565 phase lock loop TO-5	4.25
NE566 function generator 8 pin DIP	4.25
NE567 tone decoder 8 pin DIP	4.25

DIGITAL SPECIAL

Ten brand new (on carriers) dual-in-line JK flip-flops—LU321 with data sheet and two pages of application notes describing hookups for—divide by three through ten, and twelve. Also self correcting ring counter hookups, etc.

10 LU321 W/data \$4.00

LINEAR SPECIAL

Ten (10) Teleclon TO-5 741 operational amplifiers with a two-page sheet of application notes covering the basic circuits using op-amps. \$65 each Op-amp package 10-741's. data sheet and application notes only \$6.00

COUNTER IC SPECIAL

Fairchild Dual In Line 958 decade counter and Fairchild 960 nixie* driver combination. These are new and fully guaranteed but are not marked.

*Trade Mark

combination (2 IC's) \$2.75
ten sets (20 IC's) \$25.00

LINEAR IC's (dual-in-line)

709 operational amplifier	.40
710 voltage comparator	.75
LM309K 5V-1A power supply module	2.50
LM100 positive voltage reg.	.80
747 dual 741 op amp DIP	1.10

LED Red Emitting Lamp \$1.15

7480 gated full adder	.80
7483 4 bit full adder	1.60
7486 quad exclusive or gate	.65
7489 64 bit RAM	4.00
7490 decade counter	1.15
7491 8 bit shift register	1.15
7492 divide by 12 counter	1.15
7493 4 bit binary counter	1.15
74154 one of 16 decoder	3.00
74181 Arithmetic Logic Unit	6.50
24 pin DIP	2.00
9261 fast carry for above	2.00
74192 up/down decade counter	2.25
74193 up/down binary counter	2.00
74195 univ. 4 bit SR	1.15
8280 preset decade counter	1.15
8281 preset binary counter	1.15
8520 25 MC divide by "N"	2.00
2 to 15	1.15
7495 4 bit SHIPT REGISTER	1.15
8590 8 bit shift register	2.00
8270 4 bit shift register	2.00
8570 8 bit SI. PO, shift register	2.50

LSI-Calculator on a Chip

This 40 pin DIP device contains a complete 12 (twelve) digit calculator. Add, subtract, multiply, and divide. Outputs are multiplexed 7 segment MOS levels. Input is BCD MOS levels. External clock is required. Complete data is provided with chip (includes schematic for a complete calculator). \$14.95 complete with data

All IC's are new and fully tested — leads are plated with gold or solder. Orders for \$5 or more will be shipped prepaid. Add 35¢ handling and postage for smaller orders. California residents add sales tax. IC orders are shipped within two workdays of receipt of order—kits are shipped within ten days of receipt of order. Money back guarantee on all goods sold.

TTL dual-in-line	
7400, 7401, 7402, 7404, 7405, 7410, 7420, 7430, 7440.	
7450, 7451, 7453	ea. \$.25
7441 BCD decoder driver	1.15
7442 BCD decoder	1.15
7447 7 Segment decoder driver	1.60
7473 dual JK flip-flop	.65
7474 dual type D FF	.65
7475 quad latch	1.15
7476 dual JK FF	.65

BABYLON ELECTRONICS

SEND FOR FREE FLYER



P.O. Box J
CARMICHAEL, CA. 95608
(916) 966-2111

Circle 90 on reader service card

L.I. ELECTRONIC SUPERMARKET

"OFF THE WALL SELF SERVICE" OR SHOP BY MAIL

72 Spade type solderless Insulated WIRE LUG KIT	\$3.00
72 Ring type solderless Insulated WIRE LUG KIT	3.00
200 Spade & Ring solderless non-insulated WIRE LUG KIT	1.00
150 Solder Terminal Kit	1.00
100 Ft. spool #22 PVC. Stranded or Solid WIRE	1.25
80 Ft. spool #20 PVC. Stranded or Solid WIRE	1.25
60 Ft. spool #18 PVC. Stranded or Solid WIRE	1.25
50 Ft. spool #16 PVC. Stranded or Solid WIRE	1.25
10 Ft. spool 10 conductor RIBBON WIRE	1.50
50 Ft. spool 2 conductor SPEAKER WIRE	1.25
WIRE KIT—(6) 50 Ft. Spools #24 Stranded or Solid (6 colors)	3.75
WIRE KIT—(6) 50 Ft. Spools #22 Stranded or Solid (6 colors)	3.75
WIRE KIT—(6) 25 Ft. Hanks #22 Stranded or Solid (6 colors)	2.00
WIRE KIT—(6) 50 Ft. Spools TEFLON COVERED #22 Stranded	7.50
C&K Mini Switch #7101 SPDT (on-on)	1.00
C&K Mini Switch #7103 SPDT (on-off-on)	1.18
C&K Mini Switch #7201 DPDT (on-on)	1.30
C&K Mini Switch #7203 DPDT (on-off-on)	1.55
Mini Rocker Switch (on-on) (Package of 5)	1.00
1 1/2" x 19" Grey or Black Instrument Panel	1.80
5 1/2" x 19" Grey or Black Instrument Panel	2.85
Adjustable Cable TIES 4" Nylon (package of 25)	.50
Adjustable Cable TIES 6" Nylon (package of 20)	.50
Strain Reliefs (package of 20)	.60
Alignment Tool (6 piece Set)	1.98
Speaker Transformer—600 ohm center tap to 3.2 ohm	.60
Neon Bulbs Ne2 (3AD Type) Wire Leads (package of 5)	.50
12 Volt Grain-o-wheat Green, Red, Amber or Clear (pkge of 5)	.70
#327 Midflanged Bulb (package of 5)	1.50
Marco Oak Press Lite Panel Power Switch w/bulb SPDT (on-on)	1.50

DPDT—Mom. Push Button Slide Switch (Package of 5)	1.50
SPST—On-Mom. off JBT Toggle Switch	.50
New P.C. Board—G10 1 OZ.—1 SIDE COPPER-FIBREGLASS 3"x12"—\$1.00 6"x12"—\$1.75 9"x12"—\$2.00 12"x12"—\$2.50	
New P.C. Board—G10 1 OZ.—2 SIDE COPPER FIBREGLASS 3"x12"—\$1.75 6"x12"—\$2.75 9"x12"—\$3.25 12"x12"—\$3.75 (Add 25¢ Parcel Post Charge per board)	
Birtcher 2" Metal P.C. Board Retaining Slides (package of 4)	.80
P.C. Board Handles or Extractors (package of 4)	.60
Air Duct Coils 6" x 2" for 65 to 100 Watt Transmitter	2.00
Air Duct Tuning Clips (package of 6)	.75
35—1/4 Watt Resistors (YOUR CHOICE)	1.00
35—1/2 Watt Resistors (YOUR CHOICE)	1.00
25—1 Watt Resistors (YOUR CHOICE)	1.00
15—2 Watt Resistors (YOUR CHOICE)	1.00
SILVERED MICA CAPACITORS	
1 PF to 150 PF (package of 5) (specify value)	.50
180 PF to 820 PF (package of 5) (specify value)	.75
910 PF to 1500 PF (package of 5) (specify value)	1.00
CERAMIC DISCS CAPACITORS—.001MFD to .1MFD (package of 5) (Specify value)	.60
PL-259 CONNECTOR (package of 3)	1.05
175/U or 176/U REDUCER for PL-259 (package of 3)	.45
PL-258 CONNECTOR	.70
BNC PANEL MOUNT CONNECTOR (package of 3)	1.15
SPECIAL OFFER—Package of 10 Computer Boards for Stripping. Contains Resistors, Capacitors, Diodes, Relays, Transistors, Trimmers, Handles, etc. (Include 50¢ P.P. For this package)	1.50

KIMBERLY RESEARCH PRODUCTS CORPORATION

1013 MERRICK ROAD
BALDWIN, L.I., N.Y. 11510
TEL: (516) 623-3344

FREE—WITH EACH \$10.00 ORDER—FREE
50 FT. spool HEAVY WALL 600V. #22 WIRE
Send check or Money order. Include 35¢ postage for Each \$10.00 order (except where noted). MINIMUM ORDER \$3.00

Circle 91 on reader service card

MAGNETIC-PICKUP CD ignition plans. Write SES ENTERPRISES, Box 607, Ferndale, Wash. 98248

ELECTRONICS ENGINEERING & INSTRUCTION

TV TUNER REPAIRS—Complete Course Details, 12 Repair Tricks, Many Plans, Two Lessons, all for \$1. Refundable. FRANK BOCEK, Box 3236 (Enterprise). Redding, Ca. 96001

FREE information. Get FCC license new, easy way. ACADEMY OF COMMUNICATIONS TECHNOLOGY. RE-1, Box 389, Roswell, New Mexico 88201

HIGHLY Effective. Profitable Short Courses. (65 Choices). Free Literature, CIEE-E Box 10634, Jackson, Miss. 39209

WANTED

WANTED: COMPLETE SAMS PHOTOFAC 966 TO CURRENT. WRITE PRICES BOX 495, ALTUS, OKLA. 73521

UX 199 and UX 120 tubes wanted. Also data on RCA Radiola 20 model AR918. J. H. RICKERMAN, 25 Lida Lane, Rochester, N.Y. 14616

QUICK CASH for electronic EQUIPMENT, COMPONENTS, unused TUBES. Send list now! BARRY, 512 Broadway, N.Y. 10012, 212 WALKER 5-7000

FOR SALE

FREE CATALOG New Electronic Devices! World's Smallest Transmitter \$19.95! Telephone Answerer \$49.50! Telephone Recording Device \$19.95! "Bug" Detector \$59.50! Many more! SONIC DEVICES, 69-29R Queens Blvd., N.Y. 11377

EXAM MANUAL

F.C.C. MANUAL

The Original Test-Answers exam manual that prepares you at home for FCC First and Second Class Licenses. Includes Updated multiple choice tests and key schematic diagrams. PLUS - "Self-Study Ability Test" ONLY: \$9.95 Postpaid.

Tests Answers for FCC First and Second Class Commercial Licenses

COMMAND PRODUCTIONS P.O. BOX 26348 - E
RADIO ENGINEERING DIVISION SAN FRANCISCO, CALIF. 94126

REBUILD YOUR OWN PICTURE TUBES?

With Lakeside Industries precision equipment, you can rebuild any picture tube!

For complete details, send name, address, zip code to:

LAKESIDE INDUSTRIES
3520 W. Fullerton Ave.
Chicago, Ill. 60647
Phone: 312-342-3399

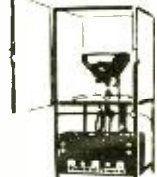



SYDMUR

NOW build your own Capacitor Discharge Ignition System for as little as \$11.45! Circuit diagram included with special ignition transformer.

TR-200 transformer
6 or 12 volts 11.45

Complete COMPAC KIT
6 or 12 volts 25.95
(as described in
POPULAR ELECTRONICS—Nov. 1966)
FREE LITERATURE on all SYDMUR "CD" Systems
SYDMUR—1268 E. 12 St.,
Brooklyn, N.Y. 11230

IC PRICES SLASHED

FACTORY FIRSTS

- SIGNETICS
- NATIONAL
- RAYTHEON

SATISFACTION GUARANTEED

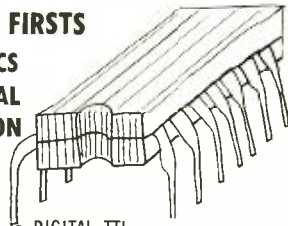

DIGITAL TTL	
7400N	27¢
7401N	27¢
7402N	27¢
7403N	27¢
7404N	29¢
7410N	27¢
7420N	27¢
7430N	27¢
7440N	27¢
7441AN	\$1.33
7442N	\$1.25
7447N	\$1.52
7451N	27¢
7454N	27¢
7472N	50¢
7473N	60¢
7474N	50¢
7475N	\$1.00
7476N	62¢
7490N	95¢
7492N	\$1.18
7493N	\$1.18
7495N	\$1.39
74107N	65¢
74121N	70¢

-----LINEAR INTEGRATED CIRCUITS-----
 DIP or TO-5 709 .45¢ 10/\$4.25 741 .50¢ 10/\$4.75
 723C TO-5 \$1.17 NE565A PLL DIP . . \$6.00

-----GENERAL PURPOSE TRANSISTORS-----
 2N5134 Si NPN or 2N5138 Si PNP . . . 15¢ 8/\$1.00

--- 1 AMP SILICON SUBMINIATURE RECTIFIERS ---
 1N4001 50 PIV, 1N4002 100 PIV, 1N4004 400 PIV
 1N4005 600 PIV 10¢/\$1.00, 100/\$7.50

Free Catalog—Large Quantity Discounts—Orders
 Less Than \$10.00 Add 25¢—Others Postpaid

DIGI-KEY PRICE PACESETTER
 FOR QUALITY IC'S
 BOX 126H
 THIEF RIVER FALLS, MN56701

Circle 93 on reader service card

LASER DISCHARGE CAPS

Brand new Laser Storage high speed discharge caps. 40 µF at 3KV each \$10



DIGITAL READOUTS	
GE Y4075 25V Miniature	\$3 ea. 10/\$25
GE Y1938 24V Standard	\$3 ea. 10/\$25
RAY CK 1905 Standard	\$3 ea. 10/\$25
MAN-3 1.7V Miniature	\$3.50 ea 10/\$30
GIANT ALPHA NUMERIC	\$3 ea. 10/\$25

3 Watt Laser Diode \$5.00

Hi-Power Varactor
 Similar to MA4060
 For Driver-Doubler-Tripler
 20 Watts Input. W/Specs \$5.00

Power Amp Strip—30 Watt \$1.00

MAGNOSTRICTIVE COMPUTER MEMORY
 Magnostriptive delay line good for approx.
 7000 bit storage. Details included. \$10.00

MM500 Dual 25 bit shift register	\$2.50
MM502 Dual 50 bit shift register	3.50
MEM 511 MOS P-channel FET	1.00
1 amp diode 1000 PIV	8/1.00 100/10.00
1 amp diode 1500 PIV	4/1.00 100/20.00
1 amp diode 1200 PIV	6/1.00 100/14.00
2 amp diode 1000 PIV	6/1.00 100/14.00
3 amp 1000 PIV full wave bridge	1.25

Please add postage for above items
 Send 25¢ for Surplus Catalog

JOHN MESHNA JR. ELECTRONICS
 P.O. Box 62 E. Lynn, Mass. 01904

Circle 94 on reader service card

Technical Excellence in Electronics.

On our small friendly campus the emphasis is on Learning as well as Learning. Extra curricular social activities, student clubs, student operated radio station, student government, new dormitory and a full sports program help provide a world of your own in which to prepare for tomorrow. Associate Degree in Engineering Electronics B.S. obtainable. G.I. approved.



VALPARAISO TECHNICAL INSTITUTE
 Dept. C, Yellowstone Trail, Valparaiso, Indiana 46383

INTEGRATED CIRCUITS

Branded, untested factory surplus and rejects. Typically over 50% usable. Satisfaction guaranteed.
 SN7403N 12 for \$1.00 LM75451N 5 for \$1.00
 SN7474N 7 for \$1.00 SN7489N 5 for \$4.00
 SN7490N 5 for \$1.00 SN74181N 5 for \$4.00
 SN7495N 5 for \$1.00 LM309H 4 for \$1.00

SPECIAL LM309K TO-3 TESTED OPERATIONAL \$1.25 ea.

Minimum order \$3.00 **E E SALES**
 Send check or money P.O. Box 2013
 order. Prepaid in U.S. Santa Clara, Ca. 95051

YEATS appliance dollies

MOST VERSATILE color TV TRUCK DEVELOPED!

NO LIFTING
 ROLLS UP & DOWN STAIRS

DeLuxe Model No. 14 \$89.50

ORDER YOURS TODAY!
 FREE illustrated brochure

Yeats Appliance Dolly Sales Co.
 1307 W. FOND DU LAC AVE.
 MILWAUKEE, WIS. 53205

Now Get MUSIC ONLY FM Programs

Convert ANY FM TUNER to receive uninterrupted commercial free music being broadcast by many stations.



New three transistor plus "Phase locked loop" IC circuit gives you perfect reception. No tuned circuits, or critical adjustments. The 1½" x 4" circuit board is powered from the tuner supply. +9 to 12 Volts DC @ 10 Ma. required.

Kit Only \$14.50
 With Squelch \$19.50
 Wired & Tested \$25.00
 With Squelch \$29.95

Plus postage and insurance THOUSANDS SOLD

Free list of FM stations with SCA authorizations included. (List alone \$.25)

Southwest Technical Products Corp.
 BOX 32040 • SAN ANTONIO, TEXAS 78284

Audio Amplifiers From SANKEN



Use For

- Stereo
- Mono
- P A Amplifier
- 4 Channel
- Instrument

These audio power amp modules are easily assembled into an excellent sound system at a fraction of the cost of factory built units. Frequency response is from 20 Hz to 100,000 Hz with less than ½% dist. Power transformers are also available in 10, 25, and 50 watts.

price • SI 1010Y 10W \$ 4.75
 • SI 1025E 25W \$14.00
 • SI 1050E 50W \$21.00

Transformers
 • 10W \$4.00
 • 25 and 50 watt \$6.00

VARIONIX P.O. Box 2586 Tri Cities, Washington 99302

Circle 95 on reader service card

HOME SECURITY and SAFETY book, featuring installation and procedure descriptions of burglar alarms. Send \$1.00 to **BRADLEY ELECTRONICS, INC.**, Dept. 111, 15 Gaval Road, Savreille, N.J. 08872

MANUALS for Govt. surplus radios, test sets, scopes, teletypes. List 25¢. **BOOKS**, 4905 Roanne Drive, Washington, D.C. 20021

CAPACITIVE DISCHARGE IGNITIONS. Nationally advertised. Discount prices. **RODGERS & SON**, Box 3583, Anaheim, Ca. 92801

B & K, Sencore test equipment, discount prices. Free catalog and price sheet. **FORDHAM RADIO**, 265 E. 149th St., Bronx, N.Y. 10451

WINDOW NEON SIGNS, SAVE TO 40% NEON TUBE CO. 251 49th SW, CANTON, OHIO 44706

ELECTRONIC Ignition—Various Types. Information 10¢. **ANDERSON ENGINEERING**, Epsom, N.H. 03239

LOGIC PROBE WITH LED DISPLAY \$20.00 POSTPAID U.S. ORDER FROM **UTI POB 252 WALDWICK, N.J. 07463**

CAPACITIVE Discharge Ignitions. HOUSTON INDUSTRIAL DESIGN, Box 10610, Houston, Tx. 77018

SOLA transformers cat #20-113-112 input 95-130V output 118V 120 VA. \$50.00 list—\$20.00 while supply lasts. **MR. ELFERS**, 2148 Ebenezer Road, Cincinnati, Ohio 45238

IGNITION. 250:1 Coil, Ballast \$7.95. Free lists. **TRANSPARK**, Carlisle, Mass.. 01741

MEMORIES SEMICONDUCTORS FREE FLYER, UTI, P.O. Box 252, Waldwick, N.J. 07463

TUBES

RADIO & TV Tubes 36¢ each. One year guaranteed. Plus many unusual electronic bargains. Free Catalog. **CORNELL** 4217-E University, San Diego, Ca. 92105

SAVE MONEY ON PARTS AND TRANSMITTING-RECEIVING TUBES, FOREIGN-DO-MESTIC. SEND 25¢ FOR GIANT CATALOG. REFUNDED FIRST ORDER. **UNITED RADIO COMPANY**, 56-R FERRY STREET, NEWARK, N.J. 07105

RECEIVING & INDUSTRIAL TUBES, TRANSISTORS, All Brands—Biggest Discounts. Technicians, Hobbyists, Experimenters—Request FREE Giant Catalog and SAVE! **ZALYTRON**, 469 Jericho Turnpike, Mineola, N.Y. 11501

new books

THE RADIO AMATEUR'S HANDBOOK, Forty-ninth (1972) Edition. Edited by The Headquarters Staff of the American Radio Relay League, Newington, Conn. 06111. 6½ x 9½ in., 704 pp including index. Soft cover, \$4.50 in U.S. and Possessions, \$5.00 in Canada, and \$6.00 elsewhere. Hard-cover clothbound, \$7.50 in the U.S., Possessions and Canada, \$8.00 elsewhere.

For years hams have known that the ARRL Handbook changed little from year to year and that a new copy every four or five years would keep you up to date. Well, that was true until Doug Blakeslee and the gang up in Newington got together to give the ham's Bible the most extensive going-over since the first post-war edition.

Approximately 48 new pages have been added and thirteen chapters have been rewritten to cover new devices and techniques. Too, it has been completely reorganized to make material easier to find.

Among the new sections in the '72 Edition are those on digital logic devices, linear IC's, broadband amplifiers, filter networks, converter designs, SSB techniques and a 28-page chapter on frequency modulation and repeaters. Two hundred new drawings and charts are used to present the material.—W2PWG

1972 WORLD RADIO-TV HANDBOOK, 26th EDITION. edited by J. M. Frost. Billboard Publishers 165 W. 46th St New York, N.Y. Distributed by Gilfer Associates, Inc., Box 239, Park Ridge, N.J. 07656 6 x 9 in., 384 pp. Softcover, \$6.95.

This "telephone directory" of international radio and television is the only annual publication detailing every facet of short wave, medium wave and TV broadcasting—from nominal information such as call sign and frequency to the name and title of the station manager. Thousands of users rely on it for schedules and programming; others refer to it for information on broadcasting organizations, station identifications, interval signals, QSL policies, etc. From the starting shortwave listener to the broadcasting industry executive, the Handbook is invaluable.

FUNDAMENTALS OF ELECTRONIC CIRCUITS by Arthur L. Pike. Prentice-Hall Inc., Englewood Cliffs, N. J. 07632. 7 x 9½ in. 700 pp. Hardcover \$15.50.

Those just beginning a serious study of electronics should find this a valuable text. Because electronic devices work in electric circuits, some previous knowledge of ac circuits is assumed. However, the opening chapter reviews the ac theory needed. Starting with such basic topics as Signal Flow and Efficiency for dc and ac signals the book goes on through diode devices and circuits, two-ports, triodes, basic amplifier circuits, feedback and pulse and ramp signals. R-E

TUBES Receiving Factory Boxed, Low Prices, Free Price List. **TRANSELETRONIC, INC.** 1306 40th Street, Brooklyn, N.Y. 11218 Telephone 212-633-2800.

TAPE & RECORDERS

FIRST BREAKTHROUGH IN RECORDING TAPE. Originally made by America's leading tape manufacturer 2400' MYLAR, 7" reel, \$2.29; 1800' MYLAR, 7" reel, \$1.69; 1200' ACETATE, 7" reel, \$.79. Write for quantity prices. AAE, 218 Columbia St., Utica, N.Y. 13502

INVENTIONS & PATENTS

INVENTIONS WANTED, Patented; Unpatented. **GLOBAL MARKETING,** 2420-AE 77th Ave., Oakland, Ca. 94605

ELECTROPLATING

PLATING EQUIPMENT, Portable Platers, Supplies and "Know-How." Build your own tanks for nickel, chrome, etc. Easy-to-install PVC liners. Rectifier components—all sizes. Schematics, parts lists, formulas, operating instructions for all plating. Guaranteed to save you 25%-75%. Some good used units for sale. Write for details, **PLATERS SERVICE COMPANY,** 1511-GG Esperanza, Los Angeles, Ca. 90023

BUSINESS OPPORTUNITIES

START SMALL, HIGHLY PROFITABLE ELECTRONIC PRODUCTION IN YOUR BASEMENT. Investment, knowledge unnecessary. Postcard brings facts. **BARTA-REC** Box 248, Walnut Creek, Ca. 94597

COMMODORE C108 ELECTRONIC CALCULATOR

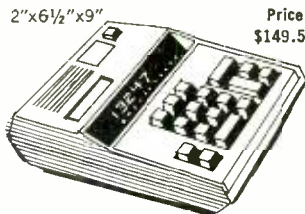

Price \$149.50

Features you would expect to find only on larger, costlier machines.

- Adds, subtracts, multiplies, divides
- Does mixed and chain calculations
- Accomplishes true credit balance examples
- Has 8-digit entry and readout
- 16-digit decimal, roundoff, LED readout
- Its error correction CI key lets you "erase" an entry without destroying earlier calculations
- Keyboard rollover memory is great for preventing inaccurate entries.

SPECIFICATIONS

Power: AC 115V/230V, 50/60 Hz
Components: Super Large Scale Integration (LSI)

Analog Devices regulated power supplies have been designed to provide complementary power for Operational Amplifiers, Function Modules, A-D and D-A Converters and Digital Logic. The supplies are completely self contained. Epoxy encapsulation provides properties close to a true hermetic seal.

Model	SE904	SE902	SE903	SE905
Output Voltage (VDC)	±15	±15	5	5
Output Current (MA)	50	100	500	1000
Price	\$18.95	\$26.95	\$22.95	\$34.95



200 PRV 15A full wave rectifier \$9.50

NE 565 Phase lock loops \$3.95
SEVEN SEGMENT COUNTER KIT

Consisting of 7 segment readout driven by 5 volts, having ¾" display, and a 7447 decoder and 7490 decade counter \$7.50
2N3819 FET \$4.50
T1543 UJT \$5.50

PROGRAMMABLE UJT's
similar to D13T with data sheet \$7.50

VARIABLE CAPACITANCE DIODES, (similar to 1N5463A) used to tune VHF, Color TV & FM broadcast sets . . . \$1.95

ER900 TRIGGER DIODES. These bidirectional trigger diodes are one of the best and cheapest methods to trigger SCR's and triacs . . . \$1.00

FLV 100 Visible LED . . . \$0.70

GaAs 1R LED . . . \$0.70

MRD 14B photo darlington . . . \$.70

2N3055 7 amp NPN silicon power transistor 115 Vce . . . \$1.00

2N3584-250 Vce NPN 2A Si transistors . . . \$1.95

1N4886 25-40W Power varactor . . . \$4.95

TRIACS

PRV	1A	10A	15A	20A*
100	.40	.70	1.00	1.20
200	.70	1.10	1.50	1.60
300	.90	1.35	1.90	2.00
400	1.00	1.60	2.70	2.40
500	1.50	2.00	3.20	2.80

*Press fit

TANTALUM CAPACITORS
4.7 MFD at 20V 5/\$1.00
10 MFD at 20V 4/\$1.00
4.7 MFD at 100V \$.50
10 MFD at 100V \$.75

NIXIE TUBES
Similar to Raytheon 8754 with socket & data sheet \$1.85

TTL IC SERIES
7400—.25 7474—.60
7401—.25 7475—.60
7402—.25 7476—1.00
7404—.27 7480—.75
7410—.25 7481—1.25
7413—.75 7483—1.20
7420—.25 7486—.57
7430—.25 7490—.79
7440—.25 7492—.80
7441—1.30 7493—.75
7447—1.15 7495—1.00
7450—.25 74107—.85
7460—.25 74121—.55
7472—.50 74192—1.92
7473—.60 8570—1.50
8590—1.50

14 Pin DIP sockets 3 for \$1.00

MINIATURE TRIM POTS
500ohm, 5K, 10K, 20K, 25K
50K \$.75 3/\$2.00

Silicon Power Rectifiers

PRV	1A	3A	12A	50A
100	.06	.09	.24	.90
200	.07	.12	.20	1.25
400	.09	.16	.35	1.50
600	.11	.20	.50	1.80
800	.15	.28	.70	2.30
1000	.20	.35	.90	2.75

400 PRV 5 amps full wave bridge. \$1.40

DECADE COUNTER KIT

CONSISTING OF:
1—NIXIE TUBE and SOCKET
1—7490 1—7475 1—7441
Special priced at \$5.25

Miniature 7 segment cold cathode neon readouts
MG-17F \$2.85

LINEAR CIRCUITS

709C operational Amp . . \$5.00
741 operational Amp . . . \$5.00
SE 501 Video Amp . . . \$1.00
748 Adjust 741 \$.95
Dual 709 \$1.39

Silicon Control Rectifiers

PRV	3A	7A	20A	70A
50	.25	.32		
100	.30	.45	1.00	3.50
200	.50	.75	1.25	6.50
300	.60	.90	1.50	
400	.70	1.10	1.75	9.50
500	.80	1.25	2.00	
600	.90	1.40	2.25	11.00

Terms: FOB Cambridge, Mass. Send check or Money Order. Include Postage. Average Wt. per package ½ lb. No. C.O.D.'s. Minimum Order \$3.00

Send for our spring catalog featuring Transistors and Rectifiers; 325 Elm St., Cambridge, Mass.

SOLID TATE SALES
Post Office Box 74D Somerville, Mass. 02143 Tel. (617) 547-4005

Circle 96 on reader service card

LIVE IN THE WORLD OF TOMORROW... TODAY! NEW PRODUCTS, NEW MATERIALS, NEW IDEAS!

UNUSUAL ECOLOGICAL SCIENCE BUYS

UNIQUE HARD-TO-FIND BARGAINS FOR FUN, STUDY OR PROFIT

WHOOOSH DUST OFF OPTICS, NEGS



Fastest, easiest, safest way to remove dust and lint from optics, negatives, slides; any hard-to-reach area. Saves hours of brushing, cleaning, spotting to get rid of microscopic dust. Patented solid propellant Fluorogel 8-oz. aerosol gives 2,500 jet sprays of moisture-free vapor. Dry air! Works in any position, even upside down! Handy 5" extension snorkle gets to it wherever. It's like having a pinpoint portable 70-lb. pressure compressor. Insists. Stock No. 60.902EH\$2.85 Ppd.

BLACK-LIGHT MIGHTY MITES

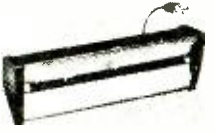

Relatively small (12") fixtures give surprisingly bright blacklight. Mirror-finished reflector makes instant starting 8-watt, high-intensity bulb look like 40-watter. Up to 5,000 hours of safe, long-wave (3660A) black-light to really turn-on parties, light & theatrical shows, psychedelic Shockproof end-caps remove for safe, easy replacement of bulb and starter. Stands upright or horizontal. Alum. case. Stock No. 71.274EH\$14.95 Ppd. DELUXE OUTDOOR/INDOOR MODEL Stock No. 71.299EH\$19.95 Ppd.

ULTRA LOW PRESSURE SENSOR



Big surplus bargain—tiny electrical pressure switch activated by only 0.02 psi air or 1/4" or less water pressure. Single pole, normally open. 10 ma 120v contact rating. 30v AC/DC (usual loads require sensitive relay or solid state control). Use as sensor, switch, control, counter, edge guide, instrument alarm. Long life (1,000,000 operations). Impervious to extreme shock/vibration. 1" sq. polycarbonate case. 3/16" diameter barbed pressure ports. Wt—10 grams. ORIGINAL COST \$11.50. Stock No. 41.623EH\$3.95 Ppd.

50-150-300 POWER MICROSCOPE



Amazing Value—3 Achromatic Objective Lenses on Revolving Turret! Color-corrected, cemented achromatic lenses in objectives give far superior results to single lenses usually found in this microscope. Price range. Results are worth the difference! Fine rack and pinion focusing. Imported! Stock No. 70.008EH\$24.50 Ppd. MOUNTED 500 POWER OBJECTIVE: Threaded achromatic lenses, 3mm F.L. Stock No. 30.197EH\$5.88 Ppd.

NEW \$99.50 HELIUM-NEON LASER!



Completely assembled. Instant-starting w/3X power output of comparable models. Steady, ripple-free light of moderate (safe) power. Excellent collimation. Simple and safe to use. 4 1/2 lb. unit reaches 75% power in 2 secs.; 100% typically 0.5 milliwatt (0.3 mW minimum) in 5 mins. Beam divergence 2 milliradians—2 cms at 40 ft. Stock No. 79.004EH\$99.50 Ppd. SINGLE MODE LASER No. 79.008EH\$129.50 Ppd.



MAIL COUPON FOR GIANT FREE CATALOG!

148 PAGES • MORE THAN 4,000 UNUSUAL BARGAINS

Completely new 1972 edition. New items, categories, illustrations. Dozens of electrical and electromagnetic parts, accessories. Enormous selection of Astronomical Telescopes, Unique lighting and ecological items, Microscopes, Binoculars, Magnifiers, Magnets, Lenses, Prisms. Many surplus items.

EDMUND SCIENTIFIC CO.
Barrington, N.J. 08007
Please rush Free Giant Catalog "EH"

Name _____
Address _____
City _____ State _____ Zip _____

AMAZING NEW Wankel Engine Kit!



Build your own see-through motorized model of revolutionary pistonless type engine, rights for which GM recently paid \$50 million! Only one considered modifiable to meet new standards. Replaces piston, cylinder, crank assemblies with rotating discs (sections removed for firing chamber). Smaller than conventional; fewer parts, greater reliability, same speed w/less horsepower. Switch. Req. 2-1.5V batt. (4 1/2"). 5" x 9". No. 71.242EH (4 1/2")\$6.75 Ppd. 5 1/2" Pg "Wankel" BOOK—#9439EH\$15.25 Ppd.

DIGITAL COMPUTER LOGIC LAB

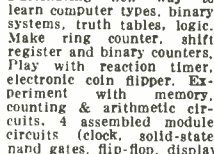

Fascinating new way to learn computer types, binary systems, truth tables, logic. Make ring counter, shift register and binary counters. Play with reaction timer, electronic coin flipper. Experiment with memory, counting & arithmetic circuits. 4 assembled module circuits (clock, solid-state NAND gates, flip-flop, display). 20 patch cords for 100's of circuits—23 computer experiments. No electronic know-how needed! 74 pg. illustr. manual explains all. Req. 6v batt. (not incl.). Stock No. 71.405EH\$39.75 Ppd.

TURN BOTTLES INTO TREASURES



Be ecological and artistic... with this low-cost Bottle Cutter Kit. Easiest-to-use one you've found. Make saleable, attractive glasses, lamps, dishes, candleholders, vases... from ordinary no-return smooth-surface bottles, jars. Cut any bottle safely, easily in less than 5 minutes for fun, profit, home decorations with superior kit. Includes cutter (3% X 7 1/4 X 2 1/4"), candle, 2-oz. grinding powder, smoothing cloth. Complete inst. Stock No. 71.475EH\$10.95 Ppd.

STARTS SEEDS IN 3 TO 5 DAYS!

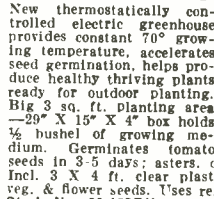

New thermostatically controlled electric greenhouse provides constant 70° growing temperature, accelerates seed germination, helps produce healthy thriving plants ready for outdoor planting. Big 3 sq. ft. planting area—29" X 15" X 4" box holds 1/2 bushel of growing medium. Germinates tomato seeds in 3-5 days; aster, dahlias, petunias, wk. or less. Incl. 3 X 4 ft. clear plastic cover, supports 4 pkgs. of veg. & flower seeds. Uses reg. home current. Stock No. 80.153EH\$12.95 Ppd.

FLEXIBLE IMAGE TRANSMITTER



Hi-resolution image-transmitter lets you see into remote, inaccessible illuminated areas; through pipes, tubes or any 1/4" opening no matter how intricate. Provides clear, wide lighting, 7X magnifying eyepiece focuses from less than 1/2" from subject to infinity. Ideal for monitoring hazardous processes, surveillance instrument, demonstrate fiber optics. Over 4,000 coherent glass fibers (.002"), 5/8" dia. semi-rigid gooseneck sheathing. Stock No. 60.857EH\$40.00 Ppd.

3" ASTRONOMICAL TELESCOPE

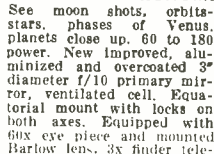

See moon, shots, orbits, stars, phases of Venus, planets close up. 60 to 180 power. New improved, aluminumized and overcoated 3" diameter f/10 primary mirror, ventilated cell. Equatorial mount with locks on both axes. Equipped with 60x eye piece and mounted Barlow lens. 3x finder telescope, hardwood tripod. Included FREE "STAR CHART": "HOW TO USE TELESCOPE" book. Stock No. 85.050EH\$32.95 Ppd. No. 80.162EH DELUXE 3"\$59.50 Ppd. Stock No. 85.105EH 4 1/2"\$94.50 FOB Stock No. 85.086EH 6"\$239.50 FOB

ELECTRONIC REMOTE CONTROL



Trigger still or movie camera, start/stop tape recorder, alarm, houselights... up to 400 ft. away. Ideal unit for selfportraits, candid, dangerous action shots, or when 2 cameras are used. No wires. Just attach transmitter to camera, screw in cable release and shoot! (Not for elec-eye cameras but operates on manual setting). Receiver, transmitter, cable release; POLAROID ADAPTER, elec. adapter cord & instrs. Req. 1 9v trans. 4 AA batt. (not incl.). Stock No. 1620EH\$51.50 Ppd.

"SEE" SOUND! "WATCH" MUSIC!

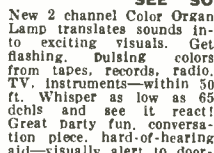

New 2 channel Color Organ Lamp translates sounds into exciting visuals. Get flashing, pulsing colors from tapes, records, radio, TV, instruments—within 50 ft. Whisper as low as 65 db! and see it react! Great party fun, conversation piece, hard-of-hearing aid—visually alert to doorbell, phone, footsteps. Plugs into any elec. outlet. 8" unbreakable, white translucent sphere, 4" dia. base. Incls 2 colored bulbs, instrs. Stock No. 71.575EH\$13.95 Ppd.

NEW ELECTRONIC CALCULATOR—\$99.50

Terrific American-made value. big machine capabilities. 1st personal electronic calculator gives silent answers in milliseconds. 3-lb.—6 1/4" X 9 1/2" high. Add, subtract, multiply, divide, do mixed calculations, 8 digit entry & readout w/16-digit cap. Auto. precision to the decimal. Has underflow, zero suppression, minus sign for true credit balance, error correction, keyboard roll over memory. Solid state; modular constr. 1 year guar. (normal use). Stock No. 78.000EH\$99.50 Ppd.

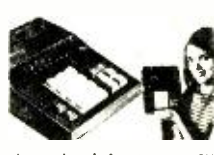

POWER HORN BLASTS A MILE

Frighten prowlers, muggers, vicious dogs with 118 decibels. Just press and this Freon powered pocket-sized horn can be heard a mile away to signal for help or fun. Great for boating (it floats), hiking, camping, hunting, seashore, rooting for your team. Can be heard over traffic and constr. noises to sound fire drill, lunch break or emergency. Weighs only 3 oz. but contains up to 100 mile-piercing blasts. Stock No. 41.423EH\$3.25 Ppd. No. 71.630 EH Giant 9-ounce horn\$8.20 Ppd.



3-CHANNEL COLOR ORGAN BARGAIN!

Create tremendous variety of unusual & beautiful lighting effects with this low-cost top-quality 1500-Watt unit (500 W. per channel). Compare with others selling for twice the price! Has pilot light, plus individual sensitivity controls and channel indicator lights. Can operate ten 150 W. "spots" or 200 Christmas lights. Uses reg. house current, attaches to audio source w/RCA-type phone plug. 3 1/2" X 2 1/4" X 2 1/4". Thermal safety plastic case. 6-ft. cord. Including complete instructions. Stock No. 71.223EH\$49.95 Ppd.

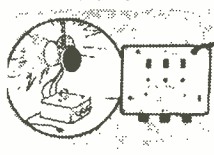

HI-VOLTAGE ELECTROSTATIC GENERATOR

Van De Graaf low-amp type. 2000,000 volt potential, yet completely safe. Demonstrates lightning, St. Elmo's fire, repulsion of charges, electrostatic dust collection, many other electrical wonders. Meter, 110v, 60 cycle, AC. Humidity range, 0-90%. Current 1.5 to 2.5 microamps. Aluminum base, frame and charge collector. Unbreakable plastic. Insulating column, 17" height, 6 1/4" diam. Full instructions. Stock No. 70.264EH\$53.75 Ppd. STATIC ELECTRICITY GENERATOR Stock No. 70.070EH\$19.50 Ppd.



SELF-PRIMING 350 G.P.H. PUMP

Lifts water 20 ft., pushes 150 ft. Drain flooded basement, aquarium, boat; fill tanks, transfer most liquids (not gasoline). Brass connections fit garden hose, 1/2" pipe. Instant self-primer pump (3 1/2" X 4 1/2" X 7 1/4") non-corrosive. Just 1 moving part. Stainless steel wear plates. System incl. handle, pump, hi-torque encl. overload protection, two suction & discharge hoses. 6-ft. heavy duty grounded cord. 10-year guarantee. Stock No. 71.440EH\$39.95 Ppd.



"FISH" WITH A MAGNET

Go treasure hunting on the bottom! Fascinating fun & sometimes profitable! Tie a line to our 5-lb. Magnet—drop it overboard in bay, river, lake or ocean. Troll it along bottom—your "treasured" haul can be outboard motors, anchors, other metal valuables. 5-lb. Magnet is war surplus—Alnico V type—Gov't. cost \$50. Lifts over 150 lbs. on land—much greater weights under water. Stock No. 70.571EH\$14.00 Ppd. Stock No. 70.570EH 3 1/2 LBS\$8.75 Ppd. Stock No. 85.152EH 15 3/4 LBS\$93.95 F.O.B.



EDMUND SCIENTIFIC CO. ORDER BY STOCK NUMBER • SEND CHECK OR MONEY ORDER • MONEY-BACK GUARANTEE

300 EDSC DRP BLDG.

BARRINGTON, NEW JERSEY 08007

if you go for four channel...

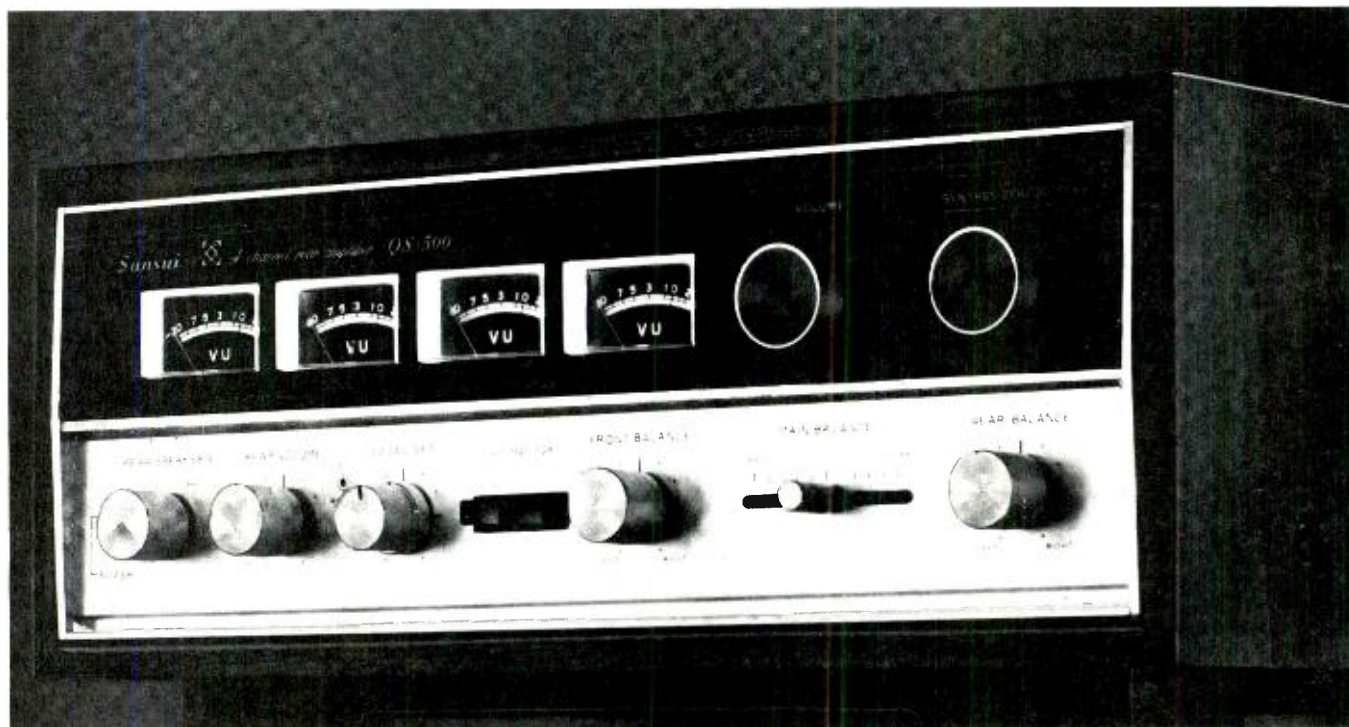

you don't have to go for broke

Buy yourself a miracle for as little as \$214.95. That's all it takes to get your conventional two-channel stereo to do anything any total four-channel receiver and control center can do, now or in the future.

The Sansui QS500 and QS100 converters are complete Four-Channel Synthesizer-Decoder-Rear-Amplifier-and-Control-Center combinations that transform standard two-channel stereo totally. The only other equipment you need is another pair of speakers.

You can decode any compatibly matrixed four-channel broadcasts or recordings and reproduce them in four authentic channels. You can detect the ambient signals present in most two-channel recordings or broadcasts and propagate them through the rear channels. In Sansui matrixing, the exclusive phase-shift technique prevents the cancellation of some signals and the change in location of others that occur in many matrixing systems. And the exclusive phase modulators restore the effect of the live sound field.

You can plug in a four-channel reel-to-reel or cartridge deck or any other discrete source. In the future — if you should have to — you can add any adaptor, decoder or what-have-you for any four-channel system for disc or broadcast that anyone's even hinted at. And a full complement of streamlined controls lets you select any function or make any adjustment quickly and positively.

The QS500 features three balance controls for front-rear and left-right, separate positions for decoding and synthesizing, two-channel and four-channel tape monitors, electrical rotation of speaker output, alternate-pair speaker selection, and four VU meters. Total IHF power for the rear speakers is 120 watts (continuous power per channel is 40 watts at 4 ohms, 33 watts at 8 ohms), with TH or IM distortion below 0.5% over a power bandwidth of 20 to 40,000 Hz. In its own walnut cabinet, the QS500 sells for \$289.95.

An alternate four-channel miracle-maker is the modest but well-endowed QS100, with total IHF music power of 50 watts (continuous power per channel of 18 watts at 4 ohms and 15 watts at 8 ohms). In a walnut cabinet, it sells for \$214.95.

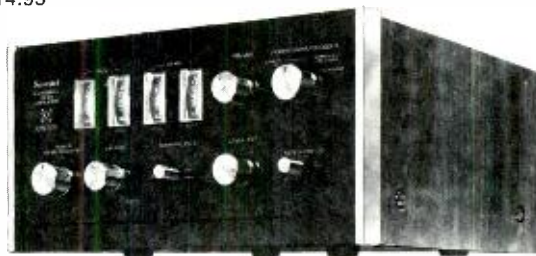

SANSUI ELECTRONICS CORP.

Woodside, New York 11377 • Gardena, California 90274

ELECTRONIC DISTRIBUTORS (Canada), Vancouver 9, B.C.

SANSUI ELECTRIC CO., LTD., Tokyo, Japan • Sansui Audio Europe S. A., Antwerp, Belgium

© COPYRIGHT BY SANSUI

Circle 86 on reader service card

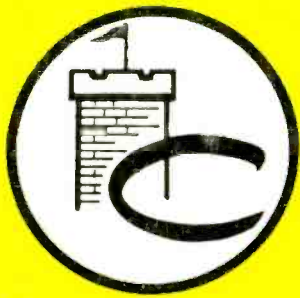

The Tuner People

*Pioneers of TV Tuner Overhauling
Originators of Complete TV Tuner Service*

Castle offers the following services to solve ALL your television tuner problems.

Universal Replacements from \$8.95

These universal replacement tuners are all equipped with memory fine tuning and uhf position with plug input for uhf tuner. They come complete with hardware and component kit to adapt for use in thousands of popular TV receivers.

STOCK No.	HEATERS	SHAFT		I.F. Snd.	PRICE
		Min.*	Max.*		
CR6P	Parallel 6.3v	1¾"	3"	41.25	8.95
CR7S	Series 600mA	1¾"	3"	41.25	9.50
CR9S	Series 450mA	1¾"	3"	41.25	9.50
CR6XL	Parallel 6.3v	2½"	12"	41.25	10.45
CR7XL	Series 600mA	2½"	12"	41.25	11.00
CR9XL	Series 450mA	2½"	12"	41.25	11.00

Castle Replacements \$15.95

Castle custom replacements made to fit in place of original tuner. Purchase outright . . . no exchange needed. Write for current list of Castle replacements, or request the part number you require (use number on ORIGINAL TUNER ONLY; do not use service literature numbers). Available for many of the popular models of following manufacturers: Admiral, Curtis Mathes, Emerson, GE, Heathkit, Magnavox, Motorola, Muntz, Philco, RCA, Sears, Sylvania, Westinghouse, Zenith and many private labels.

Tandem uhf-vhf replacements NOW \$21.95

Available in popular models of: Muntz, Olympic, Philco, Sears, Westinghouse and private labels.

Overhaul Service \$9.95

This is the service pioneered by Castle! We are now in our third decade of serving the TV Service Industry

Service on all makes and models, vhf or uhf, including transistor and color tuners . . . one price \$9.95 (does not include tuners older than 10 years). Overhaul includes parts, except tubes and transistors.

Simply send us the defective tuner complete; include tubes, shield cover and any damaged parts with model number and complaint. Your tuner will be expertly overhauled and returned promptly, performance restored, aligned to original standards and warranted for 90 days.

Dismantle tandem uhf and vhf tuners and send in defective unit only. Remove all accessories . . . or dismantling charge may apply.

Custom Exchange Service \$17.95

When our inspection reveals that original tuner is unfit for overhaul, and it is not available from our stock of outright replacements, we offer to make a custom replacement on exchange basis. Charge for this service is \$15.95 for uhf tuner and \$17.95 for vhf tuner.

If custom replacement cannot be made we will custom rebuild the original tuner at the exchange replacement price.

All replacements are new or rebuilt. All prices are f.o.b. our plant. Add shipping and handling of \$1.25 on all prepaid orders. We will ship C.O.D.

CASTLE TV TUNER SERVICE, INC.

MAIN PLANT: 5715 N. Western Ave., Chicago, Ill. 60645 • Ph. 312-561-6354
EAST: 130-01 89th Rd., Richmond Hill, N.Y. 11418 • Ph. 212-846-5300

Circle 87 on reader service card

www.americanradiohistory.com